

# Measurement technology







<b>Our expertise</b>	<b>4</b>
<b>Application areas</b>	<b>6</b>
<b>Customized solutions</b>	<b>12</b>
<b>Advantages of our transmitters</b>	<b>14</b>
<b>Our measurement accuracy</b>	<b>16</b>
<b>Differential pressure transmitters</b>	<b>18</b>
<b>Absolute pressure transmitters</b>	<b>30</b>
<b>Mobile calibration devices</b>	<b>34</b>
<b>Digital manometers</b>	<b>40</b>
<b>Calibration services</b>	<b>46</b>
<b>About halstrup-walcher</b>	<b>48</b>

## A family-owned and highly innovative supplier of customized measurement technology solutions

We offer both standardized products and customized measurement technology solutions in serial quality. With our own development department (electronics and construction) and a remarkable depth of production expertise, we master numerous product variants.

A strong quality assurance programme and lean processes have made us a highly professional partner with impressive performance in quality, deadlines and costs.

Our quality management system is certified according to ISO 9001:2015. Our responsible approach to the environment in all processes and business decisions is also certified: Environmental management system according to ISO 14001:2015.

We have long-standing, close relationships with our customers. This also applies to our approximately 200 employees and our suppliers.





# OUR EXPERTISE

## Our promise

Together with our customers, we want to drive industrial automation forward and develop transmitters for numerous application areas. We rely on the most accurate measurement technology and complement this with the appropriate housing and functionality depending on the application.

We ensure that mechanical and software components go hand in hand and that our applications are durable, high quality and practical. To achieve these goals, we are also happy to customize our products according to the customer's wishes and jointly develop sensible solutions for the desired measurement technology applications.

From the idea to the finished product, everything comes from a single source due to our high vertical range of manufacture. With our strong quality and lean orientation, we also manufacture small quantities in series quality and are constantly developing further.

The exchange with our customers is very important to us, because together we can develop the best solutions.

We look forward to supporting you as a professional partner!





## Application area: pressure maintenance in clean rooms

In cleanrooms, it must be ensured that no contaminated air flows in from corridors or areas with a lower cleanroom class. This is achieved by continuous positive pressure control. At the heart of the control system are precise differential pressure transmitters with small measuring ranges of just a few pascals. In hospitals, too, it is vital to keep the air germ-free - in the operating room, for example. Here, too, continuous positive pressure ensures that no contaminated air from surrounding rooms penetrates.

In isolation areas, the opposite principle is used: with a negative pressure relative to the surroundings, for example in quarantines, it is ensured that no pathogens can escape.

The transmitters required for positive or negative pressure control can be used either as wall-mounted variants, such as our P 26 product, or as control cabinet variants, such as the P 34. We also offer the right solutions for continuous pressure monitoring and control, which is required for all cleanrooms in ISO standard 14644, with our mobile calibration devices and our calibration services.



### Our recommendation

For checking air conditioning systems or clean rooms, for example, the digital pressure gauges of the EMA family can be used. They are easy to operate, robust, and thus optimized for long-term use in building services and industrial environments.

### You want to ensure that the pressure in your clean room remains constant?

Then we recommend our products of the differential pressure transmitters, for example the **P 34**





## Application area: mini environments

Hygiene is a key factor in the production and packaging of products in the pharmaceutical and food industries, for example. Production takes place in separate hygienic areas to prevent contamination - in classic clean rooms, in sterile hygiene booths or in separate areas within the machine, the so-called mini-environments. A stable overpressure in these hygienic areas prevents the ingress of particles from adjacent production areas.

Our pressure transmitters are at the heart of maintaining overpressure in these production areas. The sensor technology detects precise pressure differences compared to the rest of the production environment. The smallest changes in air pressure are detected by our transmitters, translated into an electrical signal and passed on to the control system.

High quality, long-term stability and reliability of the differential pressure transmitters are particularly important in the mini-environments. An automatic zero point adjustment of the sensor system, which can also be controlled by the control system ensures high accuracy for measured values close to zero, even with fluctuations in ambient temperature. In addition to the zero point adjustment, which usually takes place several times a day, regular calibrations ensure the reliability of the measuring system.

We supply various differential pressure transmitters for overpressure control and filter monitoring in process and packaging machines. With over 40 years of experience in the field of measurement technology, our products have stable measurement systems for lowest air pressures in the lower pascal range. The portfolio includes different designs with various pressure and electrical connection options, interfaces, as well as various setting options for parameterisation, including the described functions for zero point adjustment and calibration.



### Our recommendation

P 26 and P 34 are high-end transmitters with high measuring accuracy and many adjustable functions, such as the function for volume flow/mass flow measurement. Setting and parametrization can be done via a free PC program or via an operating menu (with optional display).

### For basic applications

The **PU / PI** with different accuracy classes is best suited for **basic applications**.





## Application area: calibration of measuring devices

When it comes to people's health, there are no compromises. When it comes to medical technology, reliability and accuracy are what count.

This also applies to blood pressure monitors. For example, around 70 of these devices are in use in the various wards of a nursing home in the Bernese Oberland. In addition to the requirement that these measuring devices be precise and reliable, it must be ensured that no measurement deviations occur over the months and years of use. To avoid these, an annual calibration is carried out, i.e. a comparison of the measured value with a high-precision reference value. Only measuring instruments that pass this check may continue to be used - this is required by law.

The technical service of the nursing home has the possibility to calibrate directly on site due to the mobile calibration devices. This avoids the high logistical effort. In addition to the positive environmental aspect and the saved shipping costs, the short downtime of the devices during calibration is also a major advantage compared to shipping to a laboratory.

Our mobile calibration devices combine integrated pressure generation for presetting the calibration point and high-precision pressure measurement in one device. They are suitable for mobile and stationary use and particularly suitable for very small measuring ranges. With the high long-term stability, reliability is ensured for many years.

And for customers who do not wish to commission the technical service to calibrate the device on site, we offer calibration as a service in our certified laboratory. Read more about this on page 47.



### Our recommendation

The battery-powered KAL 200 is a combination of pressure transmitter and pressure gauge. The desired pressure is specified digitally, with a control circuit ensuring fast and accurate pressure generation - an external compressed air generator is not necessary.



### You would like to have your device calibrated by us?

In our laboratory we perform different calibration services for your measuring instruments. You will receive a factory calibration certificate according to DIN EN ISO 9001:2015 or a calibration certificate according to DKD-R 6-1.

For more information visit:

[www.halstrup-walcher.de/en/products/calibration.php](http://www.halstrup-walcher.de/en/products/calibration.php)



## Customized solutions



## You have the application, we have the solution.

Let us find out together which solution is right for your application. Our experts will advise you competently and develop new solutions and products for your pressure measurement needs. Through close exchange with long-standing customers, we continuously develop our product families and create efficient solutions even for special requirements. In doing so, we are able to adapt to your needs with regard to all relevant parameters: Housing size and shape, individual design, OEM products. Our measurement parameters include differential pressure, absolute pressure, volume flow and temperature. We meet various requirements for measurement accuracy and offer both analog and digital output signals. Additional configuration options include the supply voltage, display design, the installation of LEDs and other warning functions as well as further components for integration into your application (e.g. brackets).

If you request a product which we do not yet manufacture in series, we will check how soon and to what extent we can offer you the desired solution. For this purpose, we create a specification sheet with the desired specifications, which runs through a structured product development process in close exchange between the sales, development and production departments.

### Why start a joint project?

- ① Due to our high vertical range of manufacture and lean orientation, it is possible for us to develop and manufacture other measurement technology solutions in addition to our standard products in a timely manner and, above all, with the highest quality and at the same time with the greatest efficiency.
- ② You benefit from short decision-making paths within our company. All relevant departments such as development, design, prefabrication, production are under one roof and in continuous exchange due to the optimized development process. This allows projects to be implemented in a time-saving manner.
- ③ As an established and sustainably operating company in measurement technology and with more than 75 years of experience, we are a professional partner you can count on for the long term.



## Advantages of our transmitters

1

### Piezoresistive precision measuring cells

The piezo sensor is particularly suitable for standard applications due to its small design, low shock sensitivity and wide temperature range. The measurement result is only slightly influenced by the mounting position. Pressure transmitters in which a piezo sensor is installed also benefit from a very low response time.

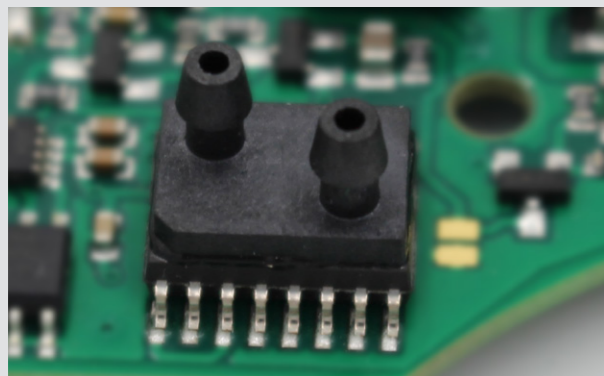

2

### Our patented measuring system

The dual choke system is developed and patented by halstrup-walcher and is manufactured in-house. It provides a differential signal which is linearized by the electronics. It is used in high quality differential pressure transmitters and digital pressure gauges. The differential transformer (LVDT) has excellent linearity. It is mainly used for pressure calibration devices

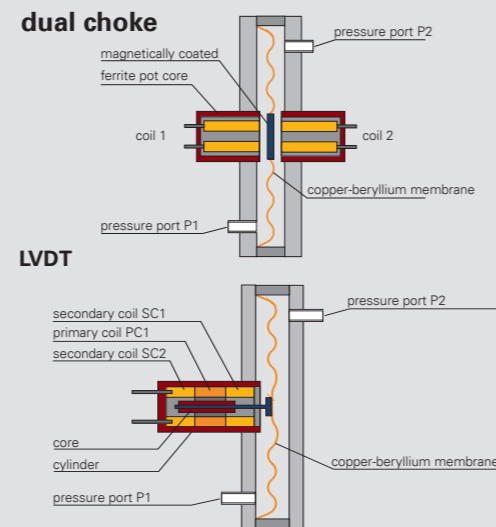

3

### High overload capacity

Our pressure measurement technology is highly precise, but at the same time it must be protected against damage. Here, our sensor technology offers the optimal solution: If the measuring cell detects too high a pressure (a peak or overload), the solenoid valves close in milliseconds. This protects the diaphragm from deformation. After a short time, a new measurement is made to determine whether normal measurement operation can be resumed. An automatic zeroing is performed. The result is optimum longevity - leading to reliability and protection of your investment at the same time.

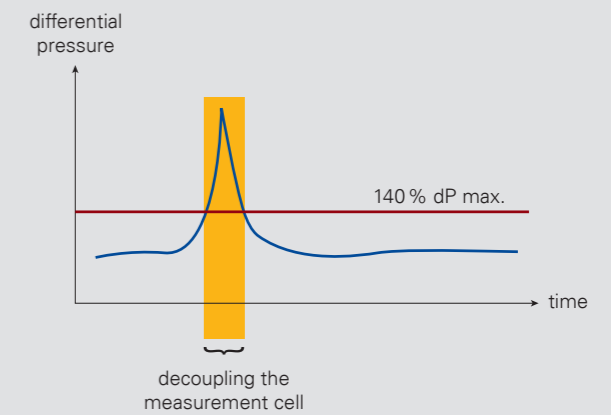

4

### Long-term stable measurement without zero-point drift

In halstrup-walcher measuring instruments, solenoid valves ensure regular zero point correction. These cyclically open both chambers of the measuring cell to the inside of the device. The microprocessor then sets the currently measured differential pressure value to zero.

This sustainably prevents drift - in addition to the long-term stable sensor technology. During this patented procedure, the previous measured value is retained so that the signal is not interrupted. Even after years of use, you have a stable and reliable measured value.

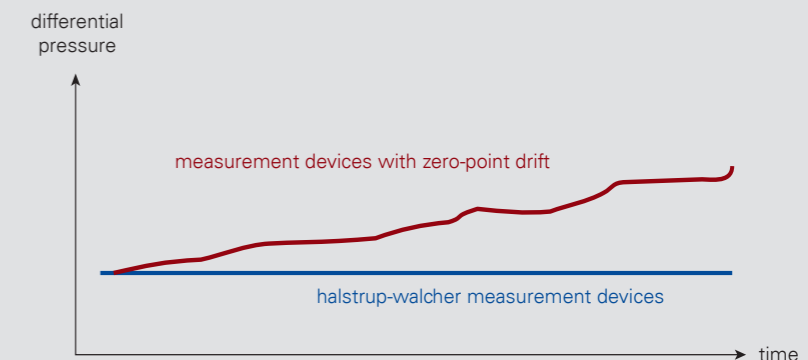

5

### Customized measuring ranges

Many of our measuring devices can be scaled to customer specifications. This allows you to integrate them optimally into your process. Below you can see three examples of scaling of the 100 Pa measuring range.

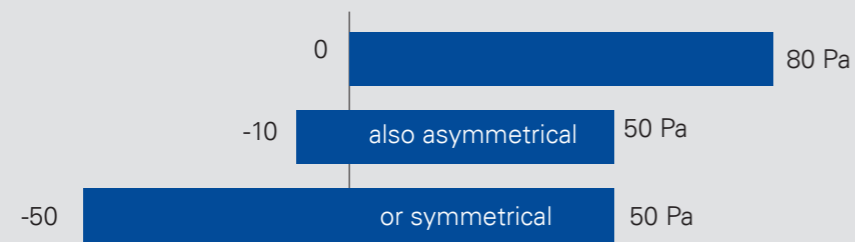

Three examples of a scale in the 100 Pa measurement range



## Our measurement accuracy

When it has to be precise, there is no room for ambiguity. To help you interpret our accuracy limits and technical features, we explain the most important terms here.

### Measurement accuracy

Measurement accuracy is a statistical quantity that takes into account „error contributions“ of the measuring device itself, but also other influences. This also includes the measurement uncertainty and the precision of the reference during adjustment in the manufacturing process.

Unless otherwise stated, specifications of the measurement accuracy always refer to the standard measurement accuracy expanded by a factor  $k=2$  (coverage probability 95.45%).

**Example:**

For the P 26 differential pressure transmitter, a measuring accuracy of „ $\pm 0.2\%$  FS“ = of the final value is offered. For a measuring range of 0..80 Pa, the final value 80 Pa must be taken into account. The measuring accuracy of the reference is additionally +0.3Pa. In the example, the measuring accuracy is calculated as follows:

- a)  $\pm 0.2\%$  FS =  $\pm 0.2\% \times 80 \text{ Pa} = \pm 0.16 \text{ Pa}$
- b) additionally + 0,3 Pa by the measuring accuracy of the reference

This results in a total measurement accuracy of  $\pm 0.46 \text{ Pa}$ . If a value of e.g. 60 Pa is measured, it can be assumed with 95% probability that the actual value lies between 59.54 Pa and 60.46 Pa (see figure).

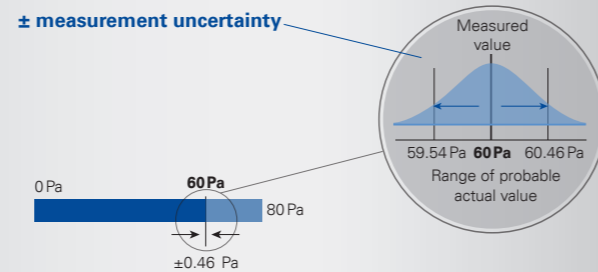

**Practical tip:** The final value of the sensor used should be approx. 10 ... 30 % above the highest expected pressure value. In this way, unexpected pressure peaks are also detected.

### Temperature coefficient span

The **temperature coefficient span** describes the maximum linear deviation if the pressure transmitter was adjusted at 20 ° C during manufacture and now measures at 35 ° C (i.e. 15 K higher), for example. For the P 26, for example, according to the data sheet, a max. of  $\pm 0.03\%$  FS / K should be applied. At 80 Pa and 35 ° C ambient temperature, this results in an additional „temperature error of the measuring span“ of:

$$\text{max. } \pm 0.03\% \text{ FS} / \text{K} \times 80 \text{ Pa} \times 15 \text{ K} = \text{max. } \pm 0.36 \text{ Pa.}$$

Since this is a specification of a maximum value, smaller deviations are to be expected in practice.



**Practical tip:** If possible, install the pressure transmitter in a protected position at room temperature. The connecting hoses from the measuring point to the transmitter can easily be chosen to be several meters long if they are not themselves subjected to heat sources.

Temperature coefficient span

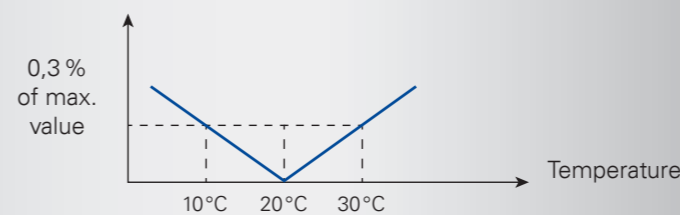

### Conversion table

	Pa	hPa / mbar	kPa	bar	psi	mmH <sub>2</sub> O	inH <sub>2</sub> O	mmHg	inHg
Pa	1	0,010	0,001	0,00001	0,0001	0,102	0,004	0,008	0,0003
hPa / mbar	100	1	0,1	0,001	0,015	10,197	0,401	0,750	0,030
kPa	1 000	10	1	0,010	0,145	101,968	4,014	7,502	0,295
bar	100 000	1 000	100	1	14,514	10 196,798	401,445	750,188	29,499
psi	6 891,799	68,966	6,894	0,069	1	703,235	27,701	51,813	2,036
mmH <sub>2</sub> O	9,804	0,098	0,010	0,000098	0,001	1	0,039	0,073	0,003
inH <sub>2</sub> O	249,004	2,490	0,249	0,00249	0,036	25,381	1	1,865	0,073
mmHg	133,316	1,333	0,133	0,00133	0,019	13,624	0,536	1	0,039
inHg	3 386,387	33,898	3,386	0,03386	0,491	345,901	13,624	25,381	1

Read the lines from left to right. Conversion example: 1 bar = 100 kPa

### You want to see our products in person?

We are represented at numerous trade fairs and will be happy to advise you. Visit us on site and let us find the ideal solution together. You can find our current trade show dates and product news at



[www.halstrup-walcher.de/en/news/](http://www.halstrup-walcher.de/en/news/)



# DIFFERENTIAL PRESSURE TRANSMITTERS

## Measure every single Pascal

Pressure gauges from halstrup-walcher are designed for non-aggressive gaseous media. For high requirements, they operate according to the inductive measuring principle. The core element is a diaphragm made of beryllium bronze. Its deflection is measured without contact by inductive displacement transducers. It is located between two measuring chambers and can thus record positive and negative differential pressure. The measuring cell does not wear out due to friction or mechanical influences.

The material beryllium bronze is very resilient. It has excellent long-term stability, good temperature behavior and very low hysteresis. This makes our high-quality pressure transmitters suitable even for the smallest measuring ranges of a few pascals.





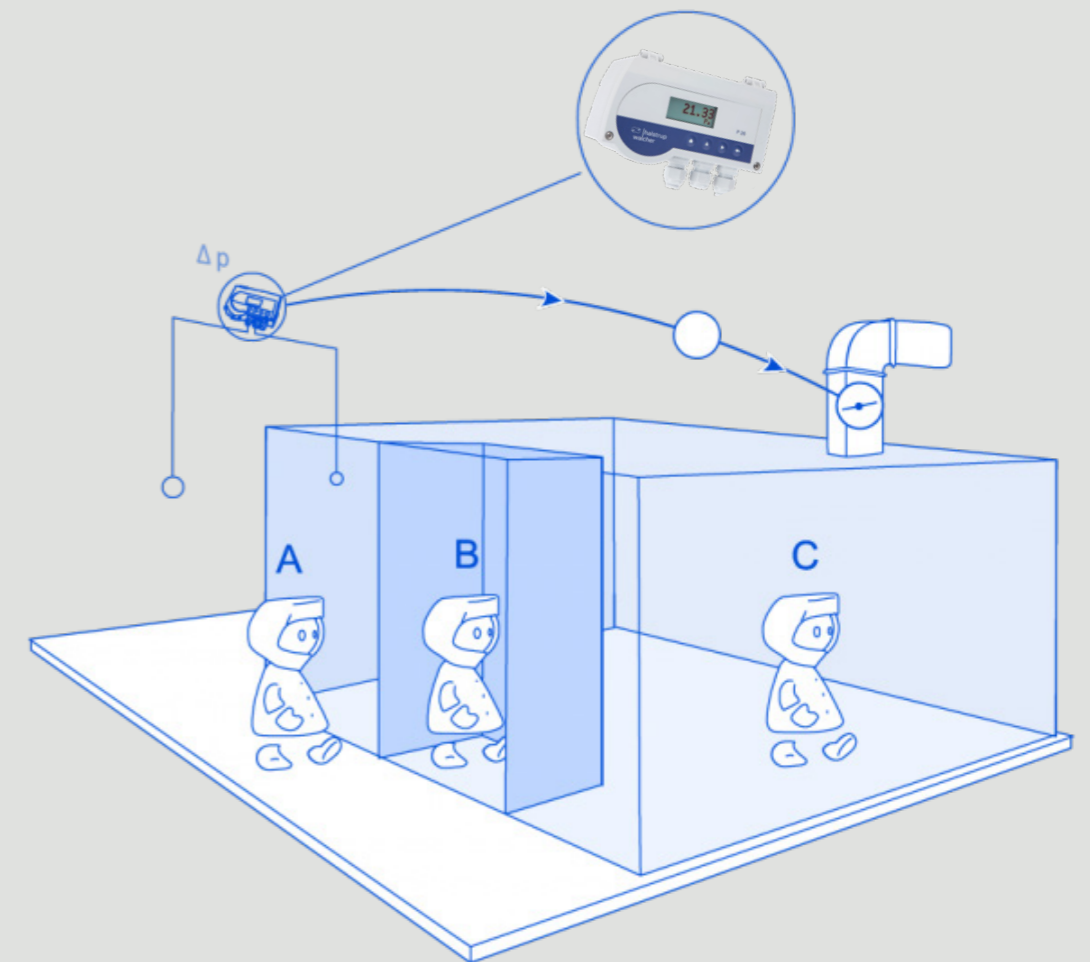

Our differential pressure transmitters for standard applications work with different measuring cells. Their functions and accuracies are matched to basic requirements. They are the economical alternative for numerous applications.

Pressure zone classification of a clean room with airlock





## Overview of differential pressure transmitters

Product	P 26	P 34	P 29	PU/PI/PIZ	PS 27	PS 17
						
<b>Application</b>	High precision, freely scalable pressure transmitter for critical applications	Measuring transmitter with very small dimensions – ideal for the control cabinet	High precision, freely scalable pressure transmitter for natural gas	For standard applications. PIZ: in two wire technology	A basic sensor for simple applications	Differential pressure-transmitter for basic applications
<b>Housing installation</b>	Mounted on a wall/ top-hat rail	Top-hat rail	Mounted on a wall/ top-hat rail	Mounted on a wall	Mounted on a wall/ top-hat rail	Mounted on a wall/ top-hat rail
<b>max. measurement range</b>	± 100 kPa		0.. 10 kPa	± 100 kPa		
<b>min. measurement range</b>	± 10 Pa		0.. 250 Pa	± 50 Pa		
<b>Measurement accuracy<sup>1)</sup></b>	± 0,2 % <sup>2)</sup> (optional) ± 0,5 % (standard)	± 0,2 % <sup>3)</sup> (optional) ± 0,5 % (standard)	± 0,2 % <sup>2)</sup> (optional) ± 0,5 % (standard)	± 0,2 % <sup>4) 5)</sup> ± 0,5 % <sup>5)</sup> ± 1 %	± 2 % (≥ 100 Pa) or ± 3 % (50 Pa) from the set measuring range	± 1 % of the set final value plus ± 0,5 Pa for measuring ranges ≤ 250 Pa: ± 1 % of the set final value ± 1 Pa
<b>Squareroot (volume flow)</b>	✓	✓ <sup>2)</sup>	✓	-	-	✓
<b>Display</b>	optional	-	optional	optional	optional	optional

<sup>1)</sup> Measurement accuracy for the reference 0.3 Pa, for measuring ranges ≤ ±1.5 kPa

<sup>2)</sup> only for measuring ranges ≤ 50 kPa

<sup>3)</sup> only for measuring ranges ≤ 25 kPa

<sup>4)</sup> only for measuring ranges ≥ 250 Pa and ≤ 50 kPa

<sup>5)</sup> not for PIZ with ± measuring ranges



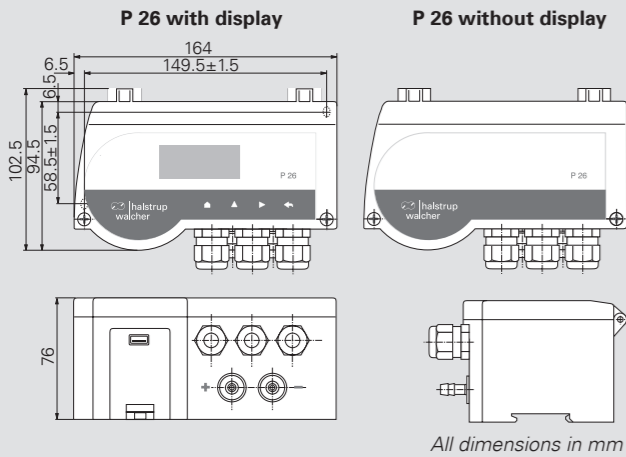

**Features**

- High precision differential pressure transmitter for air-conditioning, cleanroom and process
- Top-hat rail or wall mounting
- Wide range of units for pressure and volume flow
- Also ± measurement ranges
- Scalable measurement ranges and units
- Zero-point correction prevents zero-point drift
- Built-in valve provides a high level of overpressure protection
- Multilingual menu (English/French/German/Italian)
- Extensive configuration options using free parametrization software via internal RS232 interfaces

**Optional**

- Contact points with adjustable switching outputs
- Set the zero-point via an external interface
- Display and operating keys
- USB interface
- Air consumption meter

Measurement ranges (also ± measurement ranges) others available upon request	10/50/100/250/500 Pa 1/2.5/5/10/20/50/100 kPa freely scalable from 10..100 % within a measurement range
Measurement accuracy <sup>1)</sup>	±0.2 % FS measurement range ≤ 50 kPa or ±0.5 % FS
Temperature coefficient span	max. 0.03 % FS/K
Temperature coefficient zero point	±0% (cyclical/manual zero-point correction)
Max. system pressure/ Overload capacity	600 kPa for measurement ranges ≥ 2.5 kPa 200 x for measurement ranges < 2.5 kPa
Medium	air, all non-aggressive and non-flammable gases
Step response time (T63) (Time constant)	25 ms..60 s (adjustable)
Rated temperature range	10..50 °C
Storage temperature	-10..70 °C
Power consumption	approx. 6 VA
Weight	approx. 750 g
Cable glands	3 x M16
Pressure ports	see order code others on request clamping range Ø 5 ... 10 mm
Protection class	IP65, with USB: IP40
Certificates	CE / UKCA

<sup>1)</sup> Measurement accuracy for the reference 0.3 Pa, for measuring ranges ≤ ±1.5 kPa

Order code	A	B	C	D	E	F	G	H	I
P 26									

Output signal <sup>2)</sup> (linear/root-extracted)	A
0..10 V (R <sub>L</sub> ≥ 2 kΩ)	1
0..20 mA (R <sub>L</sub> ≤ 500 Ω)	0
4..20 mA (R <sub>L</sub> ≤ 500 Ω)	4
±5 V (R <sub>L</sub> ≥ 2 kΩ)	5

<sup>2)</sup> output signals can be configured freely

Power supply	B
24 VAC/DC ±10 %	24ACDC
24 VAC ±10 % (with galvanic separation)	24AC
230/115 VAC ±10 %	230/115

<sup>4)</sup> Supply voltage of 24 VDC required

Measurement range	C
Measurement range e.g. 0..10 Pa, -10..50 mbar, ±100 mmHg (etc.)	

Measurement accuracy	D
±0.2 % of FS <sup>3)</sup>	2
±0.5 % of FS	S

<sup>3)</sup> for measurement ranges ≤ 50 kPa

Display + keyboard	E
none	0
multi-coloured LCD and keyboard	LC



Contact point	F
none	0
air consumption meter	1
2 relays (changeover contacts) max. 230 VAC (50/60 Hz), 6 A	2

**Can be pre-set on request:**

Time constant, relay parameter, analogue output root-extracted/linear, deactivation of the cyclic zeroing

Interface	G
none	0
USB (data cable supplied)	U0
External zero-point calibration <sup>4)</sup>	0X
External zero-point calibration <sup>4)</sup> and USB (data cable supplied)	UX

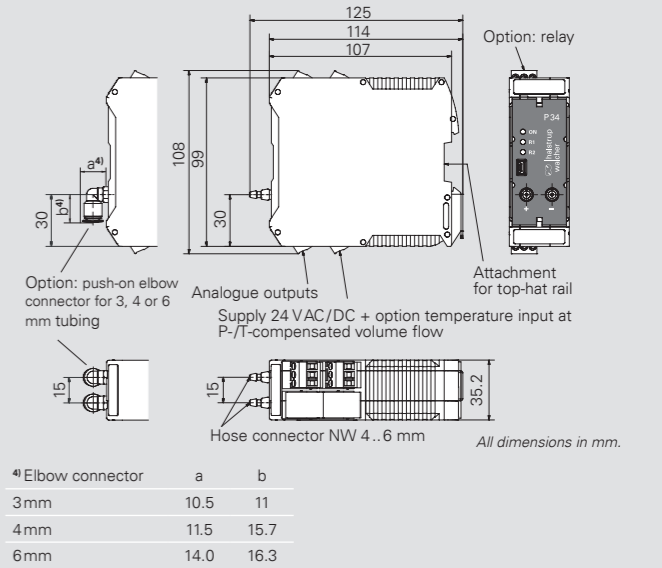

**Features**

- Differential pressure transmitter with very small dimensions – ideal for control cabinet installation
- Zero-point correction prevents zero-point drift
- Built-in valve provides a high level of overpressure protection
- Volume flow can be configured via k-factor, dP<sub>max</sub>/V<sub>max</sub> or 20 individual values
- USB interface: via PC-software scaling, characteristic line form and many other parameters can be set
- Free software available at [www.halstrup-walcher.de/en/software](http://www.halstrup-walcher.de/en/software)
- Delivery possible already completely integrated into the control cabinet (on request)

**Optional**

- P-/T-compensated volume flow (temperature analogue input and internal stat. pressure sensor)
- with relay
- with push-on elbow connector

Measurement ranges (also ± measurement ranges) others available upon request	10/50/100/250/500 Pa 1/2.5/5/10/20/50/100 kPa freely scalable from 10..100 % within a measurement range
Measurement accuracy <sup>1)</sup>	±0.2 % FS measurement range ≤ 25 kPa or ±0.5 % FS
Temperature coefficient span	max. 0.03 % of FS/K
Temperature coefficient zero point	±0% (cyclical/manual zero-point correction)
Max. system pressure/ Overload capacity	400 kPa measurement ranges ≥ 2.5 kPa 200 x measurement ranges < 2.5 kPa
Medium	air, all non-aggressive and non-flammable gases
Step response time (T63) (Time constant)	25 ms..60 s (adjustable)
Rated temperature range	10..50 °C
Storage temperature	-10..70 °C
Power consumption	approx. 6 VA
Weight	approx. 450 g
Connections	pluggable screw terminals (connection capacity 0.25..2.5 mm <sup>2</sup> )
Power supply	24 VAC/DC ±10 %
Interface	USB 2.0 Full-Speed Slave (Mini USB)
Protection class	IP20
Certificates	CE / UKCA

<sup>1)</sup> Measurement accuracy for the reference 0.3 Pa, for measuring ranges ≤ ±1.5 kPa

Order code	A	B	C	D	E	F	G
P 34							

Output signal <sup>2)</sup> (linear/root extracted)	A
0..10 V (R <sub>L</sub> ≥ 2 kΩ)	1
0..20 mA (R <sub>L</sub> ≤ 500 Ω)	0
4..20 mA (R <sub>L</sub> ≤ 500 Ω)	4

<sup>2)</sup> output signals can be configured freely

Measurement range	B
Measurement range e.g. 0..10 Pa, -10..50 mbar, ±100 mmHg (etc.)	

Measurement accuracy	C
±0.2 % FS <sup>3)</sup>	2
±0.5 % FS	5

<sup>3)</sup> for measurement ranges ≤ 25 kPa

Contact points	D
none	0
2 relays, max. 230VAC, 6A	2

Application	E
Standard	A
P-/T-compensated volume flow	B

Pressure connection	F
Hose connector NW 4/6 mm	0
Push-on elbow connector 3 mm	W3
Push-on elbow connector 4 mm	W4
Push-on elbow connector 6 mm	W6

Calibration certificate	G
none	0
Factory calibration	I
Calibration according to DKD-R 6-1	D

**Can be pre-set on request:**  
 Time constant, relay parameter, analogue output root-extracted/linear, deactivation of the cyclic zeroing

**Accessories:** USB cable



**Measured data for P-/T-compensated volume flow (optional)**

Measured range absolute pressure	200 kPa
Accuracy absolute pressure	±2.0 % FS
Temperature input	4..20 mA, R <sub>i</sub> = 130 Ω Temperature range freely scalable



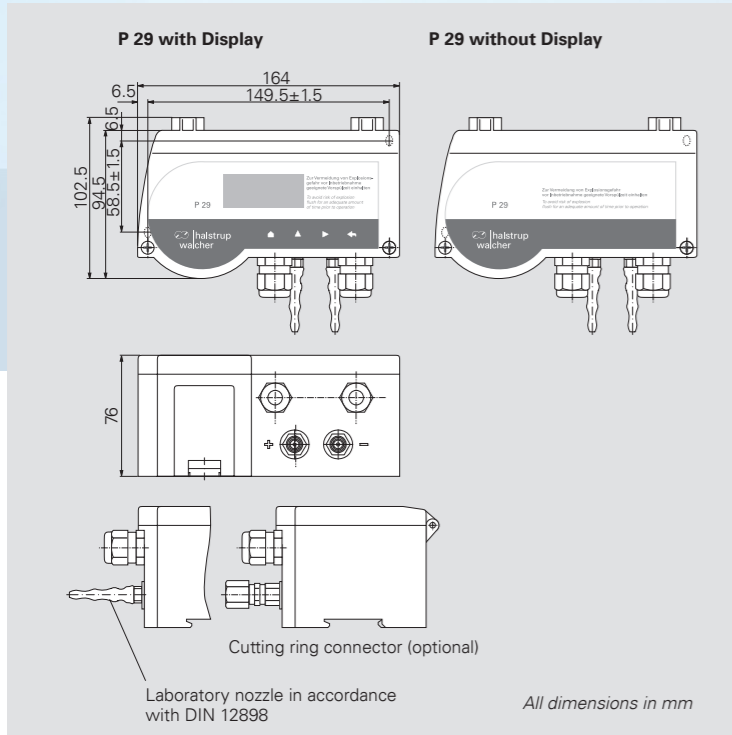

Figure: Version with display

**Features**

- TÜV-tested differential pressure transmitter for natural gas
- Design changes and technical modifications keep ignition source and gas mixture safely separated (not suitable for Ex-applications)
- Scalable measurement range and display
- For pressure and volume flow measurement
- Zero-point correction prevents zero-point drift
- Built-in valve provides a high level of overload protection
- Also suitable for top-hat rail mounting
- Multilingual menu (English/French/German/Italian)
- Extensive configuration options via: internal RS232 interfaces by means of free parameterization software or optional display and operating keys

Measurement ranges others available upon request	250/500 Pa 1/2.5/5/10 kPa freely scalable from 10..100% within a measurement range
Measurement accuracy <sup>1)</sup>	± 0.2 % FS measurement range ≤ 50 kPa or ± 0.5 % FS
Temperature coefficient span	max. 0.03 % FS/K
Temperature coefficient zero point	± 0% (cyclical/manual zero-point correction)
Overload capacity	at least 200 times, but a maximum of 100 kPa
Medium	air, all non-aggressive gases and natural gas
Max. system pressure	100 kPa for all measurement ranges
Step response time (T63) (Time constant)	25 ms..60 s (adjustable)
Rated temperature range	10..50 °C
Storage temperature	-10..70 °C
Power consumption	approx. 6 VA
Weight	approx. 750 g
Cable glands	2 x M 16 clamping range Ø 5 ... 10 mm
Protection class	IP 65
Certificates	CE/UKCA, EN1127-1:2019

<sup>1)</sup> Measurement accuracy for the reference 0.3 Pa, for measuring ranges ≤ ± 1.5 kPa

Order code	A	B	C	D	E	F	G
P 29							

<b>Output signal<sup>2)</sup></b> (linear/root-extracted)	<b>A</b>	<b>Pressure connection</b>	<b>F</b>
0..10 V (R <sub>L</sub> ≥ 2 kΩ)	1	standard for tubing ID 5..8 mm	0
0..20 mA (R <sub>L</sub> ≤ 500 Ω)	0	cutting ring coupling 6 mm	S6
4..20 mA (R <sub>L</sub> ≤ 500 Ω)	4	cutting ring coupling 8 mm	S8
± 5 V (R <sub>L</sub> ≥ 2 kΩ)	5		

<sup>2)</sup> output signals can be configured freely

<b>Power supply</b>	<b>B</b>	<b>Calibration certificate</b>	<b>G</b>
24 VDC ± 10 %	24 DC	none	0
		Factory calibration	I
		Calibration according to DKD-R 6-1	D

<b>Measurement range</b>	<b>C</b>	<b>Can be pre-set on request:</b>
Measurement range e.g. 0..250 Pa, 0..100 mmHg (etc.)		Time constant, relay parameter, analogue output root-extracted/li- near, deactivation of the cyclic zeroing

<b>Measurement accuracy</b>	<b>D</b>
± 0.2 % FS	2
± 0.5 % FS	S

<b>Display + keyboard</b>	<b>E</b>
none	0
multi-coloured LCD and keyboard	LC

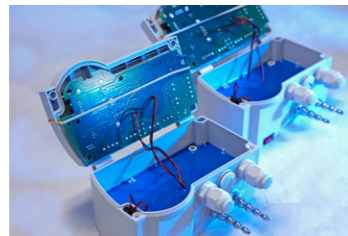

Figure: Version with 3 1/2 digit display

**Features**

- Differential pressure transmitter with linear curve for air-conditioning applications
- Also available as a two-wire system ("PIZ" model)
- Also for ± measurement ranges and asymmetric measurement ranges
- With optional LCD
- suitable for wall mounting

Measurement ranges (also ± measurement ranges) others available upon request	50/100/250/500 Pa 1/2.5/5/10/20/50/100 kPa
Measurement accuracy <sup>1)</sup>	± 0.2 % FS <sup>2)</sup> measurement ranges ≥ 250 Pa and ≤ 50 kPa or ± 0.5 % FS <sup>2)</sup> or ± 1 % FS
Temperature coefficient span	max. 0.04 % FS / K
Temperature coefficient zero point	max. ± 0.04 % FS / K
Zero point stability	0.5 % FS / year
Overload capacity	10 x for measurement ranges ≤ 20 kPa 2 x for measurement ranges > 20 kPa
Medium	air, all non-aggressive and non-flammable gases
Max. system pressure	10 kPa for measurement ranges ≤ 10 kPa max. nominal pressure of the sensor for measurement ranges above 10 kPa
Step response time (T63) (Time constant)	20 ms (factory-provided)
Rated temperature range	10..60 °C
Storage temperature	-10..70 °C
Power consumption	PU/PI: approx. 3 VA PIZ: max. 0.6 VA
Weight	approx. 800 g
Cable glands others available upon request	PU/PI: 2xPG7 PIZ: 1xPG7
Pressure ports	for tubing NW 6 mm
Protection class	IP 65
Certificates	CE/UKCA

<sup>1)</sup> Measurement accuracy for the reference 0.3 Pa, for measuring ranges ≤ ± 1.5 kPa

<sup>2)</sup> not for PIZ with ± measuring ranges

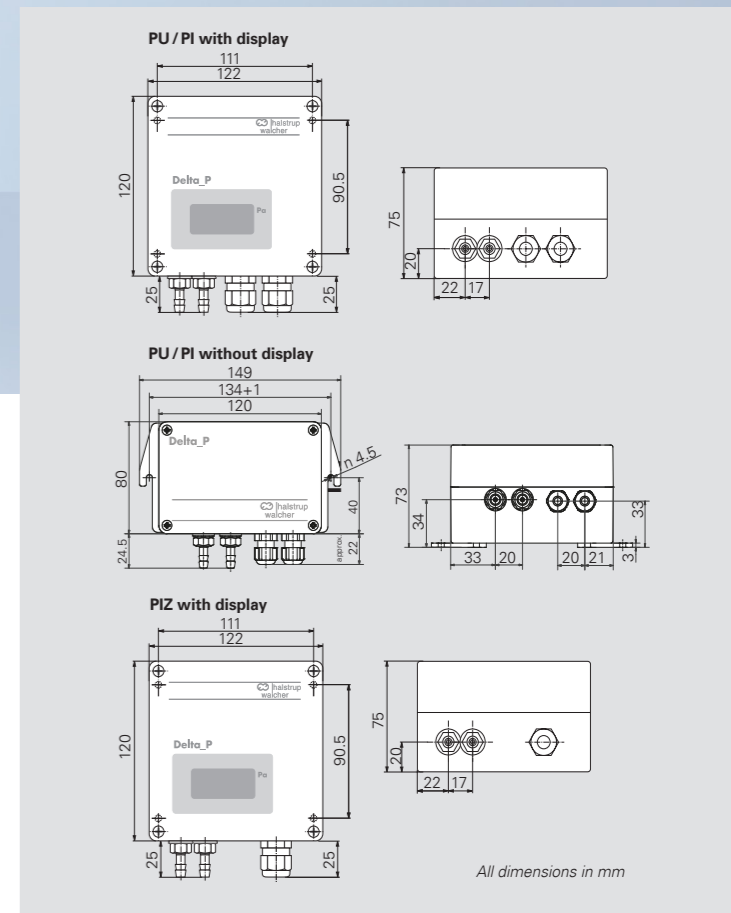

Order code	A	B	C	D	E	F	G

<b>Model</b>	<b>Output signal</b>	<b>A</b>	<b>Step response time</b>	<b>E</b>
PU	0..10 V (R <sub>L</sub> ≥ 2 kΩ)	U	none	0
PI	0..20 mA (R <sub>L</sub> ≤ 500 Ω)	I0	1 s	1
PI	4..20 mA (R <sub>L</sub> ≤ 500 Ω)	I4	2 s	2
PIZ	4..20 mA two-wire (R <sub>L</sub> ≤ 50 (U <sub>0</sub> (V)-10 (V)) Ω)	I2	5 s	5

<b>Measurement range</b>	<b>B</b>	<b>LCD</b>	<b>F</b>
Measurement range e.g. 0..100 Pa, 0..60 mbar, ± 110 mmHg (etc.)		none	0
		3 1/2 digits (see foto)	3
		4 1/2 digits (only for PU/PI)	4

<b>Measurement accuracy</b>	<b>C</b>	<b>Calibration certificate</b>	<b>G</b>
± 0.2 % FS <sup>2)</sup> only for measurement ranges ≥ 250 Pa and ≤ 50 kPa	02	none	0
± 0.5 % FS <sup>2)</sup>	05	Factory calibration	I
± 1 % FS	1	Calibration according to DKD-R 6-1	D

<sup>2)</sup> not for PIZ with ± measurement ranges

<b>Supply voltage</b>	<b>D</b>
24 VDC, +20 % / -15 % <sup>3)</sup>	24D
24 VAC, ± 10 % <sup>3)</sup> (with galvanic isolation)	24A
115 VAC, ± 10 % <sup>3)</sup>	115
230 VAC, ± 10 % <sup>3)</sup>	230
10..32 VDC (two-wire system) <sup>4)</sup>	PIZ

<sup>3)</sup> not for PIZ

<sup>4)</sup> only for PIZ



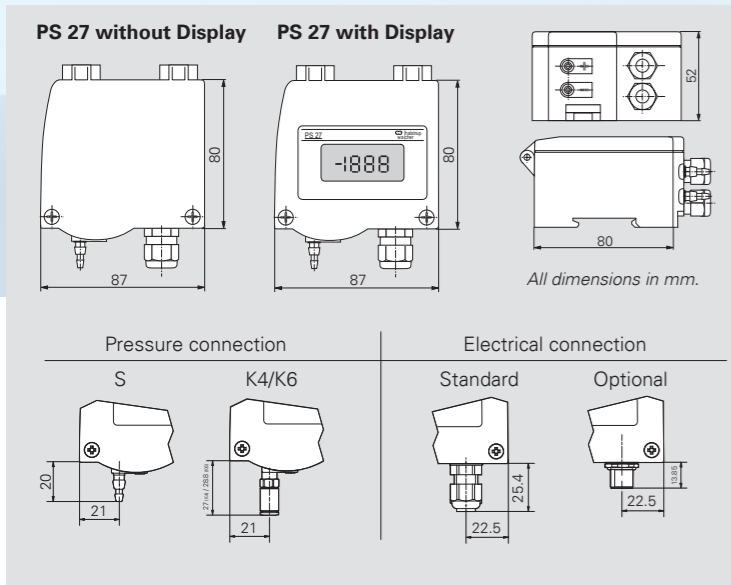

Order code	A	B	C	D	E	F	G	H
PS 27								

Output signal <sup>2)</sup>	A
0..10 V (R <sub>L</sub> ≥ 50 kΩ)	1
2..10 V (R <sub>L</sub> ≥ 50 kΩ)	2
0..20 mA (R <sub>L</sub> ≤ 500 Ω)	0
4..20 mA (R <sub>L</sub> ≤ 500 Ω)	4
0..5 V (R <sub>L</sub> ≥ 50 kΩ)	5

Contact point	D
none	0
1 relay (changeover contacts), max. 230 VAC, 6 A (min. required switching capacity 300 mW) (not for two-wire)	1

LCD	E
none	0
3 ½-digits <sup>4)</sup>	1

Step response time	F
20 ms	20
30 ms	30
60 ms	60
120 ms	120
250 ms	250
500 ms	500
1 s	1
2 s	2
4 s	4

Measurement range	C
Standard <sup>3)</sup> (e.g. 0..100 Pa)	
100 Pa/250 Pa/500 Pa/1000 Pa	1
250 Pa/500 Pa/1000 Pa/2 kPa	2
1 kPa/2.5 kPa/5 kPa/10 kPa	3
±100 Pa/±250 Pa/±500 Pa/±1000 Pa	1A
±250 Pa/±500 Pa/±1000 Pa/±2 kPa	2A
±1 kPa/±2.5 kPa/±5 kPa/±10 kPa	3A

Pressure connections	G
tube fitting 4 mm / 6 mm	S
Plug-in fitting 4 mm	K4
Plug-in fitting 6 mm	K6

Calibration certificate	H
none	0
Factory calibration	I
Calibration according to DKD-R 6-1	D

<sup>2)</sup> the output signal can be configured using DIP switches

<sup>4)</sup> display up to ± 1999

<sup>3)</sup> others available upon request, also ± measurement ranges



Figure: Version with display

**Features**

- Compact differential pressure transmitter for basic applications of the pressure measurement
- ± measurement ranges and asymmetric measurement ranges
- Either with one fixed measurement range or toggleable between 4 different measurement ranges (can be selected via DIP switches, optional)
- Suitable for top-hat rail mounting and wall surface installation
- Optionally with 2-wire technology (ZWL)
- With optional display
- With optional relay (6 A)
- Can be preset on request: Relay parameters
- Electrical connection: With M12 cable gland as standard, optional 4-pin M12 plug with A-coding

Measurement ranges (also ± measurement ranges) others available upon request	50/100/200/500 Pa 1/2.5/5/10 kPa
Measurement accuracy <sup>1)</sup>	± 3% FS for < 100 Pa or ± 2% FS for ≥ 100 Pa
Temperature coefficient span	max. 0.1% FS/K
Temperature coefficient zero point	max. ±0.1% FS/K
Air humidity (medium)	0..80% rH
Overpressure limit	50 kPa for measurement ranges ≤ 2 kPa 200 kPa for measurement ranges > 2 kPa
Medium	dry air, non-aggressive and non-flammable gases
Max. system pressure	10 kPa
Step response time (T63) (Time constant)	20ms..4s adjustable (factory-provided)
Rated temperature range	-20..60 °C; with display 0..50 °C
Storage temperature range	-20..70 °C
Power consumption	max. 1 VA
Weight	approx. 250 g
Cable glands	2 x M12 clamp range Ø 3..6.5 mm
Protection class	IP65
Certificates	CE/UKCA

<sup>1)</sup> Measurement accuracy for the reference 0.3 Pa, for measuring ranges ≤ ±1.5 kPa

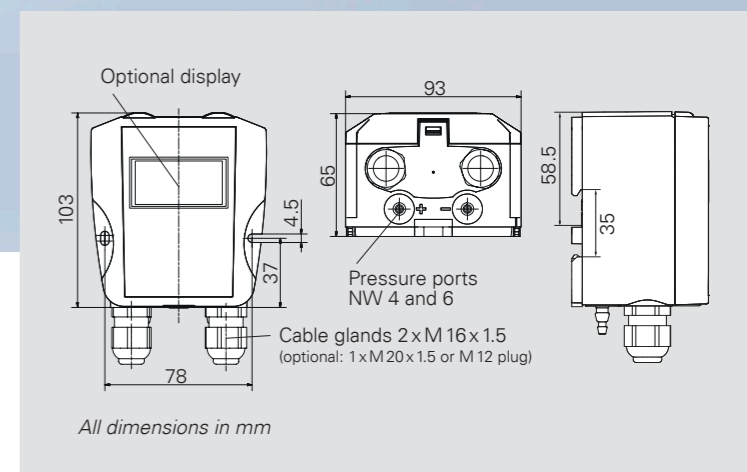

All dimensions in mm

**Features**

- Compact differential pressure transmitter for basic applications in cleanrooms, machines, HVAC or filter monitoring
- Robust ABS housing with IP67 for top-hat rail or wall mounting
- ± and asymmetric measurement ranges
- Either with one fixed measurement range or toggling between 4 different measurement ranges
- Pressure units Pa, kPa (linear output signal)
- Square-root output signal in % of max. possible value
- Configurable via DIP switches
- Zero point correction and via internal pushbutton or digital input
- Fine adjustment via internal pushbutton

**Optional**

- 3 ½ digits display
- 2-wire system (ZWL) or relay (6 A)
- Plug for easy commissioning

Measurement ranges (also ±) others available upon request	50/100/200/500 Pa 1/2.5/5/10 kPa
Measurement accuracy <sup>1)</sup> (at 22 °C)	± 1% FS ± 1 Pa measurement range ≤ 250 Pa ± 1% FS ± 0.5 Pa measurement range > 250 Pa
Temperature coefficient span	max. 0.1% value/K
Temperature coefficient zero point	±0% FS/°C (manual zero point correction), otherwise max. 0.1% FS/°C
Air humidity (medium)	0...80% rH
Max. system pressure / Overload capacity	± 25 kPa: measurement ranges ≤ 250 Pa ± 50 kPa: measurement ranges > 250 Pa
Medium	dry air, non-aggressive and non-flammable gases
Step response time (T63) (Time constant)	25 ms .. 10s (adjustable)
Rated temperature range	-10..70 °C with display: 0..50 °C
Storage temperature range	-10..70 °C with display: -5..55 °C
Calibration temperature	22 °C
Power consumption	< 1 W (optional relay: < 4 W)
Pressure ports	for tubing NW 4 and 6 mm
Protection class	IP67
Weight	approx. 200 g
Certificates	CE/UKCA

<sup>1)</sup> Measurement accuracy for the reference 0.3 Pa, for measuring ranges ≤ ±1.5 kPa

Order code	A	B	C	D	E	F	G	H
PS 17								

Output signal <sup>2)</sup>	A
0..10 V (R <sub>L</sub> ≥ 50 kΩ)	1
2..10 V (R <sub>L</sub> ≥ 50 kΩ)	2
0..20 mA (R <sub>L</sub> ≤ 500 Ω)	0
4..20 mA (R <sub>L</sub> ≤ 500 Ω)	4

Contact point	D
none	0
1 relay (exchange contacts) max. 230 VAC, 6 A (not for two-wire)	1

LCD	E
none	0
3 ½ digits <sup>4)</sup>	1

<sup>2)</sup> can be configured using DIP switches, conversion into square root signal adjustable (in % of max. possible value)

<sup>4)</sup> Display up to ± 1999

Power supply	B
24 VAC/DC ± 10% (without galvanic separation)	AC/DC ± 10% reverse pole protection
15..32 VDC two-wire (only for A=4)	ZWL
24 VDC with galvanic separation	VDC

Step response time	F
25 ms	025
1 s	1
4 s	4
10 s	10

Measurement range	C
Standard <sup>3)</sup> (e.g. 0..100 Pa)	
50 Pa/100 Pa/200 Pa/250 Pa	1
100 Pa/200 Pa/750 Pa/1,25 kPa	2
250 Pa/500 Pa/1 kPa/2,5 kPa	3
1 kPa/2,5 kPa/5 kPa/10 kPa	4

Electrical connection	G
spring-type terminal, 2 x M16 cable glands clamping range Ø 5...10 mm	16
spring-type terminal, M20 cable gland <sup>5)</sup> clamping range Ø 8...13 mm	20
M12 plug <sup>5)</sup>	12

switchable	1 kPa/2,5 kPa/5 kPa/10 kPa	4
	± 50 Pa/± 100 Pa/± 200 Pa/± 250 Pa	1A
	± 100 Pa/± 200 Pa/± 750 Pa/± 1,25 kPa	2A
	± 250 Pa/± 500 Pa/± 1 kPa/± 2,5 kPa	3A
	± 1 kPa/± 2,5 kPa/± 5 kPa/± 10 kPa	4A

<sup>5)</sup> not for changeover contacts / relay (D)

Calibration certificate	H
none	0
Factory calibration	I
Calibration according to DKD-R 6-1	D

Can be pre-set on request: relay parameter

<sup>3)</sup> also ± measuring ranges



## Accessories and software

### Accessories

#### Connection parts

Silicone tubing ID 5 mm, AD 9 mm, red (please state length required)	9601.0003
Silicone tubing ID 5 mm, AD 9 mm, blue (please state length required)	9601.0004
Norprene tubing ID 4,8 mm, AD 8 mm, black (please state length required)	9061.0002
Y-piece for tubing, NW 5mm	9601.0171

#### Pressure connections

You can also obtain numerous customized pressure connections from us, e.g. various cutting ring fittings or hose nozzles.

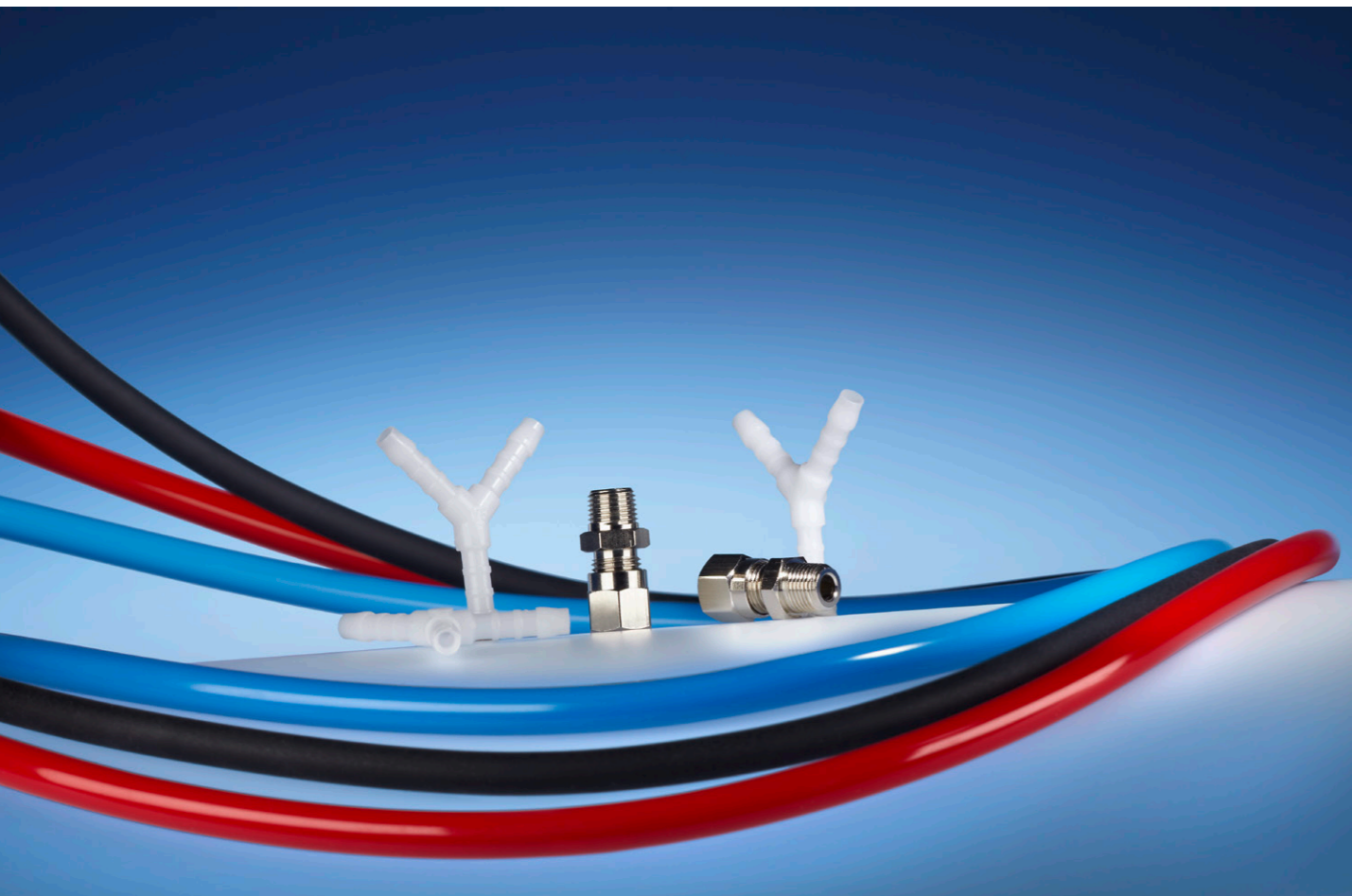

### Application software

You can set the parameters for our instruments or monitor and record measurements using a PC via a USB or RS232 interface. These features are supported by our free user software. This also allows you to transfer your settings to other devices by saving and reusing them.

Our user software is compatible with the following pressure transmitters: P 26, P 34 and P 29.

You can download the software here:  
[www.halstrup-walcher.de/en/software](http://www.halstrup-walcher.de/en/software)

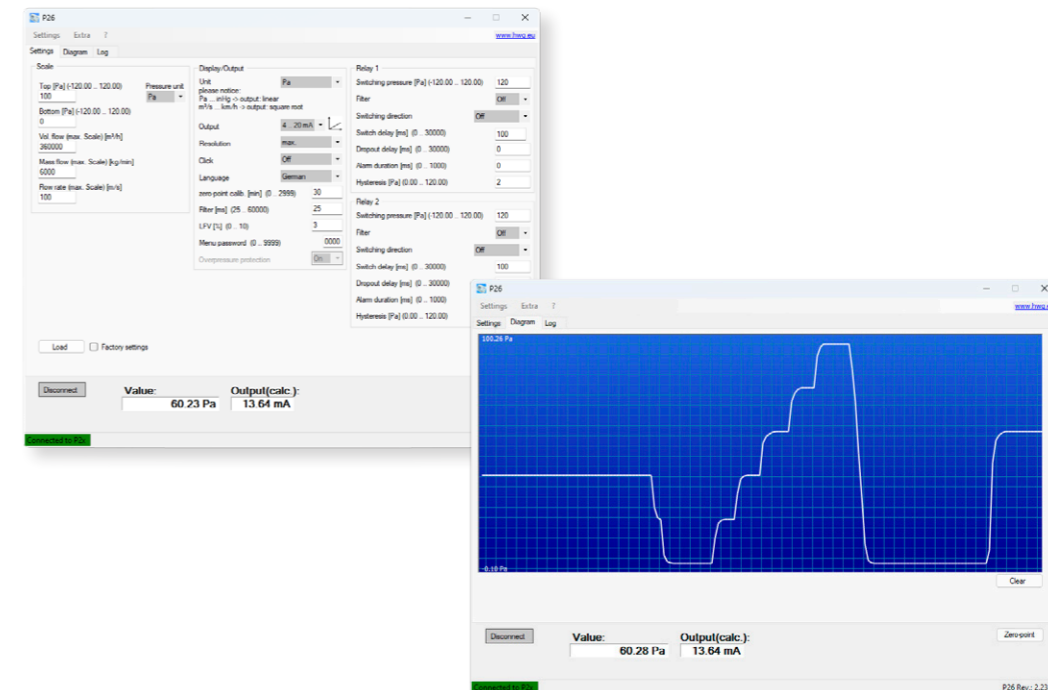

### Calibration services

You can also have our devices tested and confirmed in our accredited calibration laboratory in accordance with DKD-R 6-1 or as a factory calibration. Our trained experts will be happy to advise you on the calibration of our pressure measurement devices. Recalibration of third-party devices that are included in our scope of accreditation is also possible. If required, we offer adjustment for pressure measurement products manufactured by halstrup-walcher. In addition, we offer you further services within the scope of calibration, please contact us.

You can find more information at: [www.halstrup-walcher.de/en/products/calibration.php](http://www.halstrup-walcher.de/en/products/calibration.php)



To place your order, please call us at  
**+49 7661 3963-0** or email us at  
**info@halstrup-walcher.com.**  
For additional contacts, please visit  
[www.halstrup-walcher.de/en/contact](http://www.halstrup-walcher.de/en/contact)



# ABSOLUTE PRESSURE TRANS MITTERS

## Measuring absolute pressure in closed systems

To determine the barometric pressure, you need an absolute pressure measurement. This compares the currently measured pressure with the vacuum. The barometric pressure measurement records (weather-dependent) ambient pressures, i.e. approx.  $1\,013.25\text{ hPa} \pm 50\text{ hPa}$ . With absolute pressure measurement, other pressure values can also be referenced to the vacuum - depending on the selected measuring range (e.g. 75 hPa).

The precise determination of the barometric pressure is used on the one hand for weather determination. On the other hand, air conditioning systems are often referenced to the current barometric pressure in order to avoid excessive pressure differences, for example in entrance areas / air curtains. A precise absolute pressure measurement is needed in numerous scientific and production processes - wherever a (weather independent) process pressure value is required. A common example is pressure compensation of volume flow measurements.

The AD 1000 is suitable for displaying absolute pressure and with the help of the BA 1000 barometric air pressure can be displayed. The core of the devices are evacuated measuring cells made of spring-elastic copper material. The deflection of the measuring cell caused by the absolute pressure or the air pressure is detected inductively without contact. The absolute pressure transmitters provide an electrical output signal proportional to the pressure.



## Overview of absolute pressure transmitters

	AD 1000	BA 1000
<b>Features</b>	Absolute pressure transmitter	Atmospheric pressure transmitter
<b>Measurement range</b>	0..50 kPa 0..100 kPa 80..120 kPa 90..110 kPa 100..0 kPa	80..120 kPa 85..115 kPa 90..110 kPa 95..115 kPa
<b>Measurement accuracy<sup>1)</sup></b>	± 1% FS	
<b>Display</b>	3 ½-digit (optional)	

<sup>1)</sup> Reference ± 0.5 hPa with respect to sea level

## Accessories

Silicone tubing ID 5 mm, AD 9 mm, red (please state length required)  
 Silicone tubing ID 5 mm, AD 9 mm, blue (please state length required)  
 Noreprene tubing ID 4,8 mm, AD 8 mm, black (please state length required)  
 Y-piece for tubing, NW 5mm

Order no.
9601.0003
9601.0004
9061.0002
9601.0171

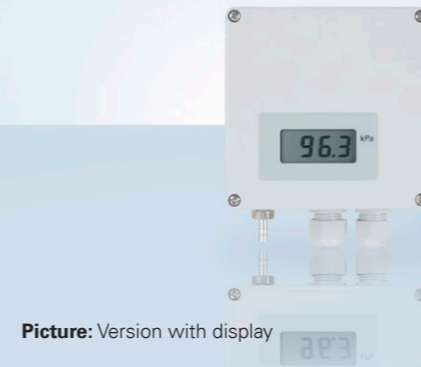

Picture: Version with display

### Features

- Precise absolute pressure transmitter
- AD: for absolute pressure
- BA: for atmospheric pressure
- High level of accuracy and long-term stability
- Little zero-point drift or hysteresis; largely independent of temperature
- The size of the optional display can be adjusted (reduced) in the factory to correspond to the height of the installation site, see DIN ISO 2533 (only BA 1000)

Measurement accuracy <sup>1)</sup>	± 1% FS
Temperature coefficient span	max. 0.04 % FS/K
Temperature coefficient zero point	max. ± 0.04 % FS/K
Calibration temperature	22 °C ± 4 K
Operating temperature	10..60 °C
Storage temperature	-10..70 °C
Medium	air, all non-aggressive and non-flammable gases
Signal stability	0.3 hPa/year
Reduction	0..850 m above sea level (only BA 1000) (please indicate when placing your order)
Power consumption	approx. 3 VA
Cable glands	2 x PG 7 (housing without display) clamping range Ø 3 ... 6.5 mm 2 x PG11 (housing with display) clamping range Ø 5 ... 10 mm
Protection class	BA 1000: IP53; AD 1000: IP54
Weight	approx. 600 g
Pressure ports <sup>2)</sup>	for tubing NW 6 mm
Certificates	CE/UKCA

<sup>1)</sup> Reference ± 0.5 hPa with respect to sea level

<sup>2)</sup> AD 1000: 1 pressure port, BA 1000: no pressure port

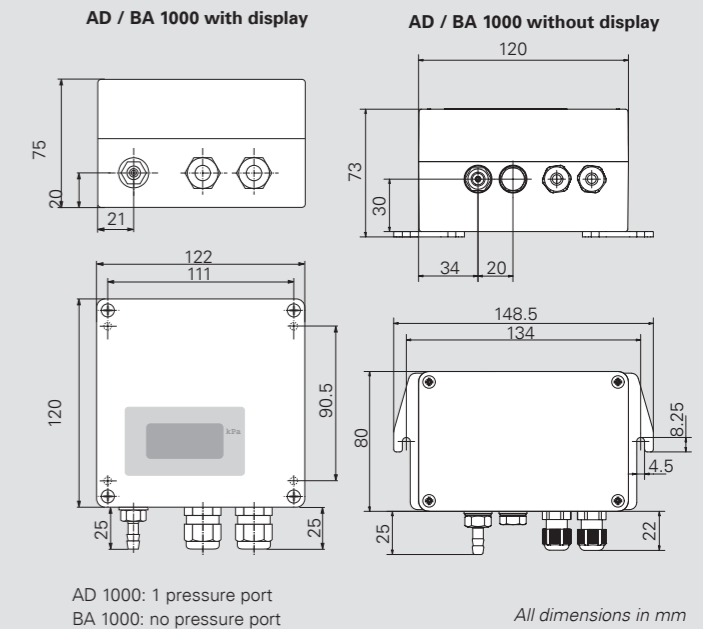

Order code	A	B	C	D	E	F
AD-BA 1000						

Product	Measurement range	A
AD 1000	0..50 kPa	50A
	0..100 kPa	100A
	80..120 kPa	80A
	90..110 kPa	90A
	100..0 kPa	0A
BA 1000	80..120 kPa	80B
	85..115 kPa	85B
	90..110 kPa	90B
	95..115 kPa	95B

Output signal	B
0..10 V (R <sub>L</sub> ≥ 2 kΩ)	1
0..20 mA (R <sub>L</sub> ≤ 500 Ω)	0
4..20 mA (R <sub>L</sub> ≤ 500 Ω)	4

Power supply	C
24 VDC, +20 % / -15 %	24D
24 VAC, ±10% (50/60 Hz)	24A
115 VAC, ±10% (50/60 Hz)	115
230 VAC, ±10% (50/60 Hz)	230

LCD	D
none	0
3 ½ digit	3

Reduction <sup>3)</sup>	E
none	0
please indicate in meters (e.g. 2 m) <sup>3)</sup>	

<sup>3)</sup> only for BA 1000

Calibration certificate	F
none	0
Factory calibration	W
Calibration according to DKD-R 6-1	D



# MOBILE CALIBRATION DEVICES

## On-site calibration: an alternative to external laboratories

Calibration is used to check whether a measuring instrument measures the correct values. For this purpose, a target/actual comparison is performed with a traceable reference device. In all areas where sensitive measurement technology is used, such as in the manufacture of sensors, calibration of the devices used is necessary. This is the only way to ensure quality standards and avoid faulty processes and products from the outset. For companies that want to obtain or retain ISO 9001 certification, regular calibration of test equipment is mandatory. If pressure transmitters need to be calibrated regularly and quick availability of the equipment is required, mobile calibration devices are a suitable alternative to the more time-consuming calibration service provided by an external laboratory.



At halstrup-walcher you will find various pressure calibrators with an excellent price-performance ratio, which can be used both stationary (e.g. in a customer's own laboratory) and mobile. They combine an integrated pressure generation for presetting the calibration point and a highly precise pressure measurement. To use the calibration device as a reference, it should be calibrated according to DKD-guideline 6-1.

The mobile calibration device is particularly suitable for the calibration of

- differential pressure measuring instruments in clean rooms (pharmaceuticals, semiconductors, etc.)
- blood pressure measuring devices in hospitals or similar
- differential pressure measuring instruments in air conditioning systems



## Overview of mobile calibration devices

	KAL 100	KAL 200	KAL 84
			
<b>Pressure generation</b>	automatic		manual
<b>Applications</b>	mobile or stationary (laboratory)		
<b>Measurement ranges</b>	0..100 Pa/0..200 Pa/0..500 Pa/0..1 kPa/0..2 kPa/ 0..5 kPa/0..10 kPa/0..20 kPa/0..50 kPa/0..100 kPa/ ±100 Pa/±200 Pa/±500 Pa/±1 kPa/±2 kPa/ ±5 kPa/±10 kPa/±20 kPa/±50 kPa/-80..100 kPa		0..100 Pa (0..1 mbar) 0..1 kPa (0..10 mbar) 0..10 kPa (0..100 mbar) 0..100 kPa (0..1000 mbar) 0..300 mmHg (0..400 mbar)
<b>Measurement accuracy<sup>1)</sup></b>	±0.2 % FS Measurement ranges >0..200 Pa / ±200 Pa  ±0.5 % FS Measurement ranges ≤0..200 Pa / ±200 Pa	±0.1 % FS Measurement ranges >0..200 Pa / ±200 Pa  ±0.2 % FS Measurement range 0..200 Pa / ±200 Pa  ±0.3 % FS Measurement ranges 0..100 Pa / ±100 Pa	±0.2 % FS ± 1 digit Measurement ranges 1..50 kPa  ±0.5 % FS ± 1 digit
<b>Temperature coefficient span (10..40 °C)</b>	max. 0.04 % FS/K	max. 0.03 % FS/K	max. 0.04 % FS/K
<b>USB-Interface and analog measurement input for test object</b>	optional	✓	-
<b>Battery life</b>	approx. 8 h	approx. 8 h	approx. 2 h
<b>Calibration certificate<sup>2)</sup></b>	✓	✓	optional
<b>Power supply test object (24 VDC / 100 mA)</b>	optional	✓	-

<sup>1)</sup> Measurement accuracy for the reference 0.3 Pa, for measurement ranges ≤±1,5 kPa

<sup>2)</sup> If a calibration certificate according to DKD-R 6-1 is selected, the factory calibration certificate is not included.

## Accessories



**Transport case KAL 100/200**  
Order no. 9220.0002



**Carrying bag KAL 100/200**  
supplied as standard



**Carrying bag KAL 84**  
Order no. 9062.0001



**Hand pump KAL 84**  
Order no. 9601.0036

## Application software for the KAL 100/200

Control your calibration process from the PC. The calibration devices KAL 100/200 with USB connection can be operated with our user software. You can choose between the following operating modes: setpoint mode, pressure measurement and test mode.

You can define calibration points and approach them automatically. Save a calibration sequence once defined and use it again for another or the same pressure transmitter.

Use the software to conveniently set parameters that you would otherwise set via the operating menu of the display (unit, language (English/French/German/Italian/Spanish), zeroing,...).

You can find the free user software at:

[www.halstrup-walcher.de/en/downloads](http://www.halstrup-walcher.de/en/downloads)

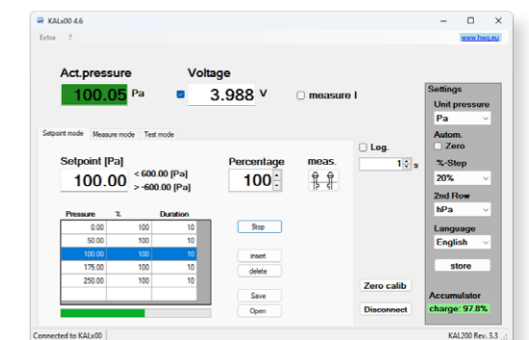

To place your order, please call us at **+49 7661 3963-0** or email us at [info@halstrup-walcher.com](mailto:info@halstrup-walcher.com). For additional contacts, please visit [www.halstrup-walcher.de/en/contact](http://www.halstrup-walcher.de/en/contact)



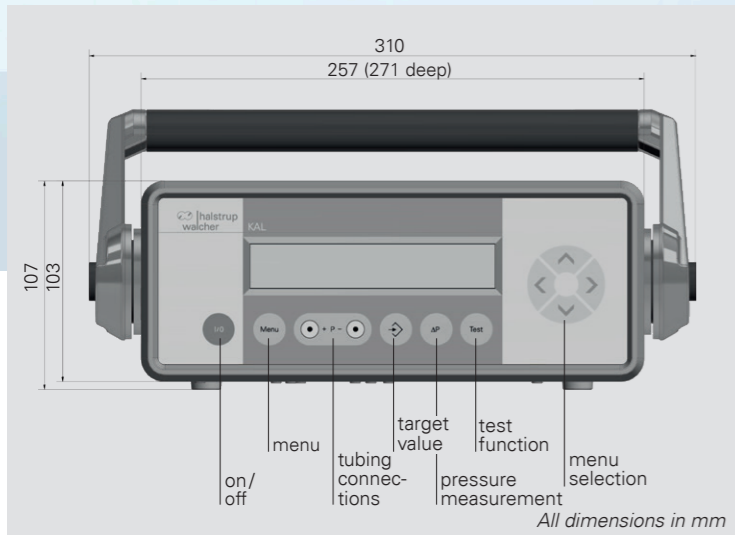

**Properties / Benefits**

- High precision measurement and calibration device
- High flexible while it runs on mains supply or battery
- Automatic zero-point correction provides high zero-point stability
- Internal pump quickly and accurately generates negative or positive differential pressures of -80 kPa up to 100 kPa
- Unit conversion (e.g. mmHg, mmH<sub>2</sub>O, psi, etc.)
- Ensuring the calibration interval by displaying the last calibration
- Switching power supply for automatic adjustment of the voltage supply between 85 VAC and 264 VAC for the worldwide use

Order code	A	B	C	D	E
KAL					

Model	A	Power supply	C
KAL 100	100	85 .. 264 VAC, (47 .. 63 Hz)	0
KAL 200	200	85 .. 264 VAC, (47 .. 63 Hz) and Lithium-ion Accumulator	A

Measurement ranges	B	Interface	D
0.. 100 Pa	0	none	0
0.. 200 Pa	02	USB + measurement input for test object <sup>2)</sup>	1
0.. 500 Pa	05		
0.. 1 kPa	1		
0.. 2 kPa	2		

<sup>2)</sup> Standard for KAL 200

Calibration certificate	E
Factory calibration	I
Calibration according to DKD-R 6-1 <sup>3)4)</sup>	D

<sup>3)</sup> If a calibration certificate according to DKD-R 6-1 is selected, the factory calibration certificate is not required.  
<sup>4)</sup> Calibration according to DKD-R 6-1 only for pressure indication

0.. 100 Pa	100
± 100 Pa	0A
± 200 Pa	02A
± 500 Pa	05A
± 1 kPa	1A
± 2 kPa	2A
± 5 kPa	5A
± 10 kPa	10A
± 20 kPa	20A
± 50 kPa	50A
-80.. 100 kPa	100A

KAL 100/200 Series 3		
Measurement accuracy <sup>1)</sup>	KAL 100:	KAL 200:
Measurement ranges > 0..200 Pa/±200 Pa	± 0.2 % FS	± 0.1 % FS
Measurement ranges ≤ 0..200Pa/±200 Pa	± 0.5 % FS	± 0.2 % FS
Measurement ranges 0.. 100 Pa/± 100 Pa	± 0.5 % FS.	± 0.3 % FS
Control accuracy of the Pressure generation	≤ 0.05 % FS	
Overload capacity	200x measurement range, max. 600 kPa	
Temperature coefficient zero point	± 0% (cyclical/manual zero-point correction)*	
Calibration temperature	22 °C ± 4 K	
Medium	air, all non-aggressive and non-flammable gases	
Measurement input	0.. 10 V, 0.. 20 mA Measurement accuracy: 0.2 % FS	
Display	Alphanumeric display with 2 x 20 characters, backlighting	
Rated temperature range	10 .. 40 °C	
Storage temperature	-10 .. 70 °C	
Weight	approx. 4.600 g	
Pressure ports	Ø 6 mm, for tubing NW 5 mm	
Certificates	CE/UKCA	

<sup>1)</sup> measurement accuracy for the reference 0.3 Pa, for measurement ranges ≤ ±1,5 kPa

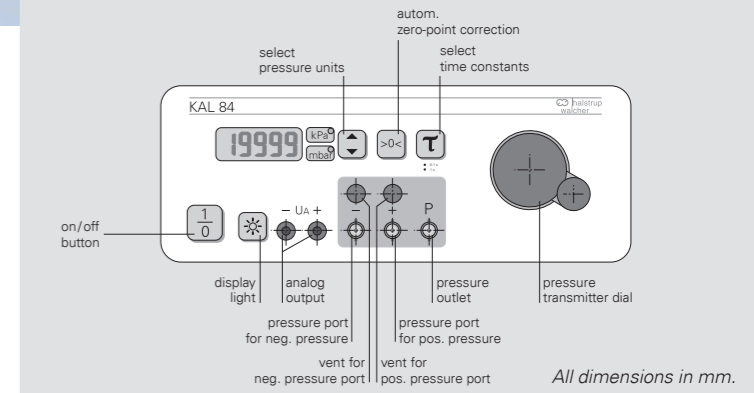
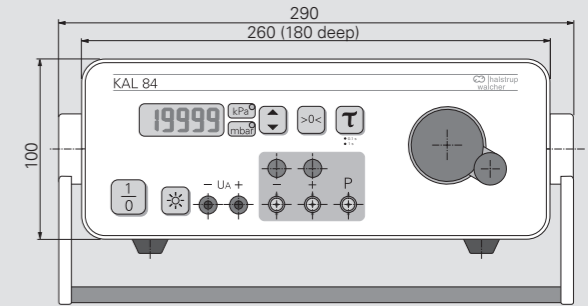

**Features**

- Highly accurate and reproducible results
- Internal pressure generation using pressure bellows and hand pump
- Very rugged and light: excellent for service applications
- Unit conversion, e.g. mmHg/kPa, mbar/kPa
- Rechargeable battery allows for portable operation
- 90-264 V AC plug-in power supply

Measurement accuracy <sup>1)</sup>	± 0.2 % FS + ± 1 digit measurement ranges 1..50 kPa ± 0.5 % FS + ± 1 digit
Hysteresis	0.1 % FS
Temperature coefficient zero point	± 0% FS/°C (manual zero-point correction)
Temperature coefficient span	max. 0.04 % FS/K
Calibration temperature	22 °C ± 4%
Medium	air, all non-aggressive and non-flammable gases
Displacement volume	approx. 100 cm <sup>3</sup> (measuring ranges > 100 Pa) approx. 200 cm <sup>3</sup> (measuring range 100 Pa)
Output signal	0.. 1 V (R <sub>L</sub> ≥ 2 kΩ) 2 connectors Ø 4 mm
Display	4 ½ digit LCD character height = 10 mm
Time constants	toggles between 0.1 s; 1 s
Operating temperature	10 .. 40 °C
Storage temperature	-10 .. 70 °C
Power supply	Ni-MH rechargeable 9 V battery with AC adaptor
Weight	approx. 3.000 g
Pressure ports	for tubing NW 6 mm
Certificates	CE/UKCA

<sup>1)</sup> Measurement accuracy of the reference 0.3 Pa for measuring ranges ≤ ±1.5 kPa

Order code	A	B	C
KAL 84			

Measurement ranges <sup>2)</sup>	A
0.. 100 Pa (0.. 1 mbar)	0
0.. 1 kPa (0.. 10 mbar)	1
0.. 10 kPa (0.. 100 mbar)	10
0.. 100 kPa (0.. 1 000 mbar)	100
0.. 300 mmHg (0.. 400 mbar)	300

<sup>2)</sup> others available upon request

Measurement accuracy	B
± 0.5 % FS ± 1 digit	1
± 0.2 % FS ± 1 digit for measurement ranges 1..50 kPa (optional)	2

Calibration certificate	C
none	0
Factory calibration	I
Calibration according to DKD-R 6-1	D

# DIGITAL MANO METERS

## Easy on-site pressure measurement

In air conditioning systems and clean rooms, many pressure values have to be checked after commissioning and in the course of maintenance or validation. For example, the fan pressure or the pressure drop at units and filters must be checked. Likewise, the overpressure in the clean room or the flow in the ventilation duct and in rooms must be measured regularly and documented accordingly.



Hand-held pressure gauges are used for uncomplicated on-site measurement. With their compact design and focus on core functionalities, they are geared towards measuring pressure differences in these application areas. Thanks to the user-friendly displays, the measured values are quickly visible and can be read easily.

Our EMA family of digital manometers are optimized for long-term use in building services and industrial environments. They are easy to use and robust, while providing precise measurement even at the smallest pressure differences.





## Overview of digital manometers

	EMA 200	EMA 84
		
<b>Features</b>	Digital manometer with min./max. value memory and free selection of units, also suitable for flow measurements	Rugged digital manometer
<b>Measurement ranges</b>	± 200 Pa (± 2 mbar) ± 2 kPa (± 20 mbar) ± 20 kPa (± 200 mbar) ± 200 kPa (± 2 000 mbar)	0.. 100 Pa (0.. 1 mbar) 0.. 1 kPa (0.. 10 mbar) 0.. 10 kPa (0.. 100 mbar) 0.. 100 kPa (0.. 1 000 mbar)
<b>Measurement accuracy <sup>1)</sup></b>	± 0.5 % FS at 22 ° C	± 0.2 % FS measurement ranges 1.. 10 kPa or ± 0.5 % FS measurement ranges 1.. 100 kPa or ± 1 % FS

<sup>1)</sup> Measurement accuracy for the reference 0.3 Pa, for measuring ranges ≤ ±1.5 kPa

The EMA 200 can be ordered in 4 different measurement ranges. The units can be changed as required: Pa and kPa are shown in the display; mbar, mmH<sub>2</sub>O, and in H<sub>2</sub>O are printed on the housing film and marked with an arrow. The temperature or rate of flow is shown in a second line on the display.

The EMA 84 can also be ordered with 4 different measurement ranges. The following units may be selected: Pa/mbar and mbar/kPa.

## Accessories

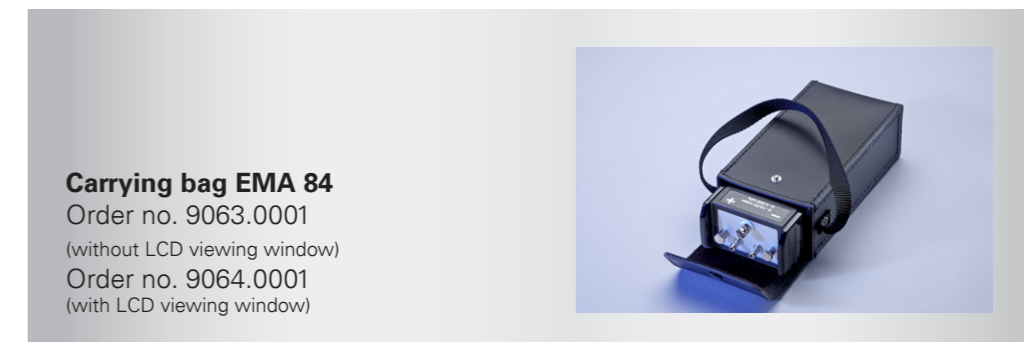
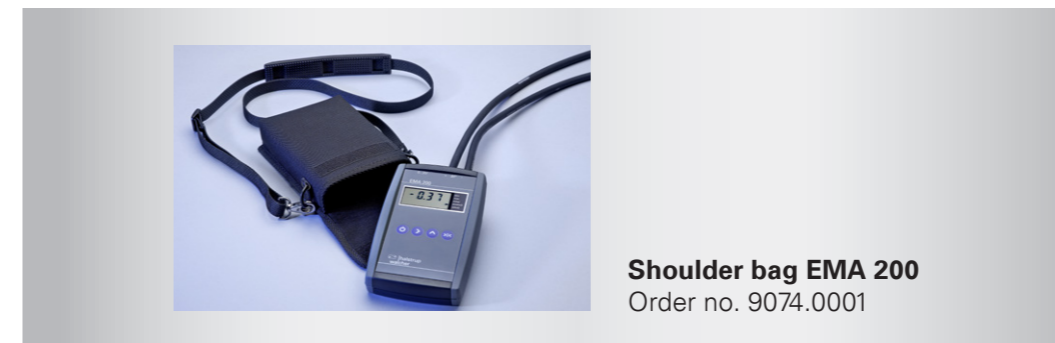

- Silicone tubing ID 5 mm, AD 9 mm, red (please state length required) Order no. 9601.0003
- Silicone tubing ID 5 mm, AD 9 mm, blue (please state length required) Order no. 9601.0004
- Norprene tubing ID 4,8 mm, AD 8 mm, black (please state length required) Order no. 9061.0002
- Y-piece for tubing, NW 5mm Order no. 9601.0171
- Telescoping pitot tube for flow measurements (EMA 200) Order no. 9061.0193

### Telescoping pitot tube for flow measurements

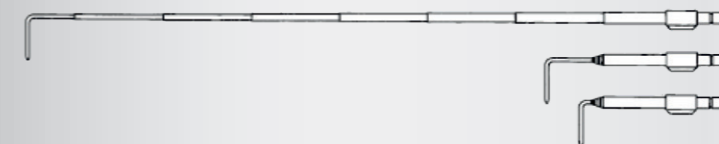

Max. working length: 980 mm  
Min. working length: 250 mm  
Transport length: approx. 200 mm

## EMA 200



output signal 3.5 mm jack plug

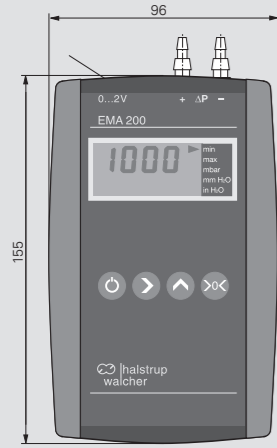

All dimensions in mm

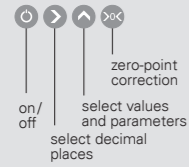

Connection diagram

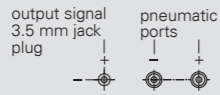

Order code	A	B
EMA 200		

Measurement range	A		
± 200 Pa (± 2 mbar)	1.5.. 18 m/s	0	
± 2 kPa (± 20 mbar)	5.. 58 m/s	1	
± 20 kPa (± 200 mbar)	15.. 180 m/s	10	
± 200 kPa (± 2000 mbar)		100	

Calibration certificate	B		
none	0		
Factory calibration	W		
Calibration according to DKD-R 6-1	D		

### Features

- High-end pressure gauge for differential pressure and flow measurements
- Adjustable pitot factor and density
- Zero-point correction at the push of a button
- Min./max. value memory
- Temperature measurement
- Time constant (damping) adjustable for measuring of strongly fluctuating input pressures

Measurement accuracy <sup>1)</sup>	± 0.5 % FS at 22 °C
Temperature coefficient span	max. ± 0.04 %/°C FS
Temperature coefficient zero point	max. ± 0.04 %/°C FS (for gradual changes in temperature)
Overload capacity	10 x for measurement ranges ≤ 20 kPa 2 x for measurement ranges 200 kPa
Calculation of air speed (in m/s)	$v = \text{pitot factor} \cdot \sqrt{(2 \cdot \Delta p) / \text{air density}}$ pitot factor and density adjustable, $\Delta p$ = differential pressure at the pitot tube [Pa] with telescoping pitot tube
Zero-point correction	performed electronically by pressing zero-point key
Medium	air, all non-aggressive and non-flammable gases
Output signal	0.. 2 V ( $R_L \geq 2 \text{ k}\Omega$ )
Display	3 ½ digit LCD, character height = 10 mm
Time constant (damping) (adjustable)	1.. 10 s
Operating temperature	0.. 50 °C
Storage temperature	-10.. 70 °C
Power supply	9 V battery (service life approx. 100 h) (display reads "low bat" when power falls below a certain minimum level); Switches off automatically after approx. 20 min.
Weight	approx. 400 g
Pressure ports	for tubing NW 4 or 6 mm
Certificates	CE/UKCA

<sup>1)</sup> Measurement accuracy for the reference 0.3 Pa, for measuring ranges ≤ ±1.5 kPa

## EMA 84



### Features

- Very robust digital pressure gauge
- Ideal for service technicians, easy-to-read display
- High level of accuracy
- Manual zero-point correction
- With optional output signal for writer or power/voltage logger

Measurement accuracy <sup>1)</sup>	± 0.2 % FS measurement range 1.. 10 kPa or ± 0.5 % FS measurement range 1.. 100 kPa or ± 1 % FS
Overload capacity	10 x for measurement range ≤ 10 kPa 2 x for measurement range > 10 kPa
Zero-point correction	via potentiometer on front face
Medium	air, all non-aggressive and non-flammable gases
Output signal	0.. 1 V ( $R_L \geq 2 \text{ k}\Omega$ ) BNC connector
Display	3 ½ digit LCD, character height = 13 mm
Time constants	toggles between 0.02 s; 0.2 s; 1 s
Operating temperature	10.. 60 °C
Storage temperature	-10.. 70 °C
Operating position	preferably horizontal
Power supply	9 V battery
Weight	approx. 800 g
Pressure ports	for tubing NW 6 mm
Certificates	CE/UKCA

<sup>1)</sup> Measurement accuracy for the reference 0.3 Pa, for measuring ranges ≤ ±1.5 kPa

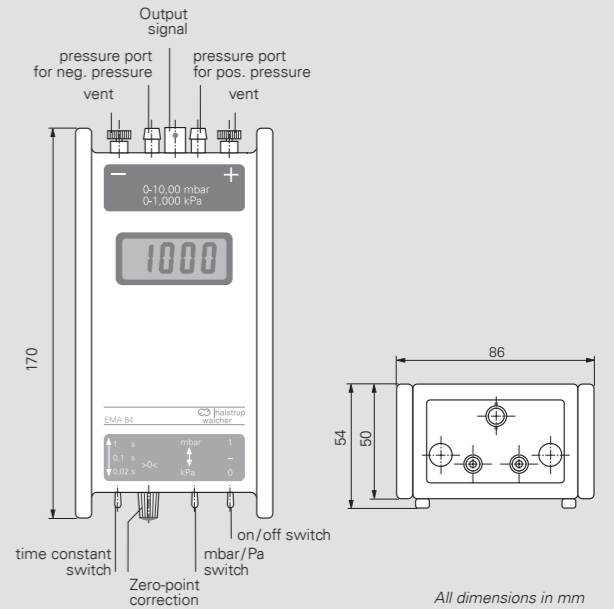

All dimensions in mm

Order Code	A	B	C	D
EMA 84				

Measurement range	A			
0.. 100 Pa (0.. 1 mbar)	0			
0.. 1 kPa (0.. 10 mbar)	1			
0.. 10 kPa (0.. 100 mbar)	10			
0.. 100 kPa (0.. 1000 mbar)	100			

Measurement accuracy	B			
± 0.2 % FS measurement range 1.. 10 kPa	2			
± 0.5 % FS measurement range 1.. 100 kPa	5			
± 1 % FS	1			

Output signal	C			
none	0			
0.. 1 V (optional)	1			

Calibration certificate	D			
none	0			
Factory calibration	W			
Calibration according to DKD-R 6-1	D			



# CALIBRATION SERVICES

## Maintain quality standards with calibrations

### Calibrations according to DKD-R 6-1

DAkkS calibration should be performed at measurement points which are critical to the quality of the product or service. It follows a recognised, standardised procedure (e.g. in accordance with DKD-R 6-1) and the uncertainty of the calibration is stated. The DAkkS certificate is internationally recognised and documents seamless traceability to national standards.





### Factory calibrations according to ISO standard

ISO factory calibration is suitable for instruments used as auxiliary devices for reference measurement and development purposes, e.g. in management of reference materials in accordance with ISO 9001. In contrast to the DAkkS calibration, the ISO factory calibration does not state the uncertainty. ISO factory calibrations are performed in the production laboratory of halstrup-walcher using traceable references. As an additional service, halstrup-walcher also performs adjustments to its own pressure transmitters.

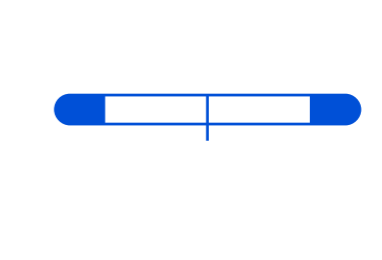

Our calibration laboratory has been accredited as a member of the German Calibration Service (DKD) since 1999. Since 2010, the Deutsche Akkreditierungsstelle GmbH (DAkkS) has accredited our calibration laboratory according to DIN EN ISO / IEC 17025 for the calibration of the measurand pressure. The accreditation is valid for the scope of accreditation listed in the document attachment D-K-21048-01-00 (accreditation certificate).

We offer calibrations for all makes, regardless of type and manufacturer. Our high-precision test equipment, which we use as reference devices during calibration, is calibrated at regular intervals at accredited calibration laboratories with highly accurate reference standards and thus directly traced back to the national standard.

	<p>0.25</p>  <p>20</p>		
<p>Calibration of differential pressure transmitters, calibration devices, absolute pressure transmitters and portable manometers</p>	<p>Absolute pressures from 0.25 bar to 20 bar in gases (laboratory medium: dry, purified air)</p>	<p>Negative and positive overpressures from -75 mbar to 20 bar in gases (laboratory medium: dry, purified air)</p>	<p>Preparation of calibration certificates according to DKD-guideline 6-1 or documentation of a calibration according to ISO 9001</p>

## Post-calibration service

Calibration according to DKD-R 6-1  
Factory calibration certificate

**Order no.**  
9601.0288  
9601.0136

# ABOUT HALSTRUP- WALCHER

## Other business areas

### Drive technology

As a machine builder, your customer expects you to provide highly flexible machine solutions with minimal change-over times. A new format is to be set automatically and with high precision in the shortest possible time. And you want to offer your customers optimum machine availability - supported by condition monitoring of the components.

With the positioning systems, halstrup-walcher offers intelligent miniature drives with motor, gearbox, position control, 10 different bus interfaces on board and a variety of designs and performance features.



### Services

You have an application where you want to use measurement technology or mechatronic drives, but cannot find a suitable product?

halstrup-walcher develops the solution you need and delivers even in small quantities.

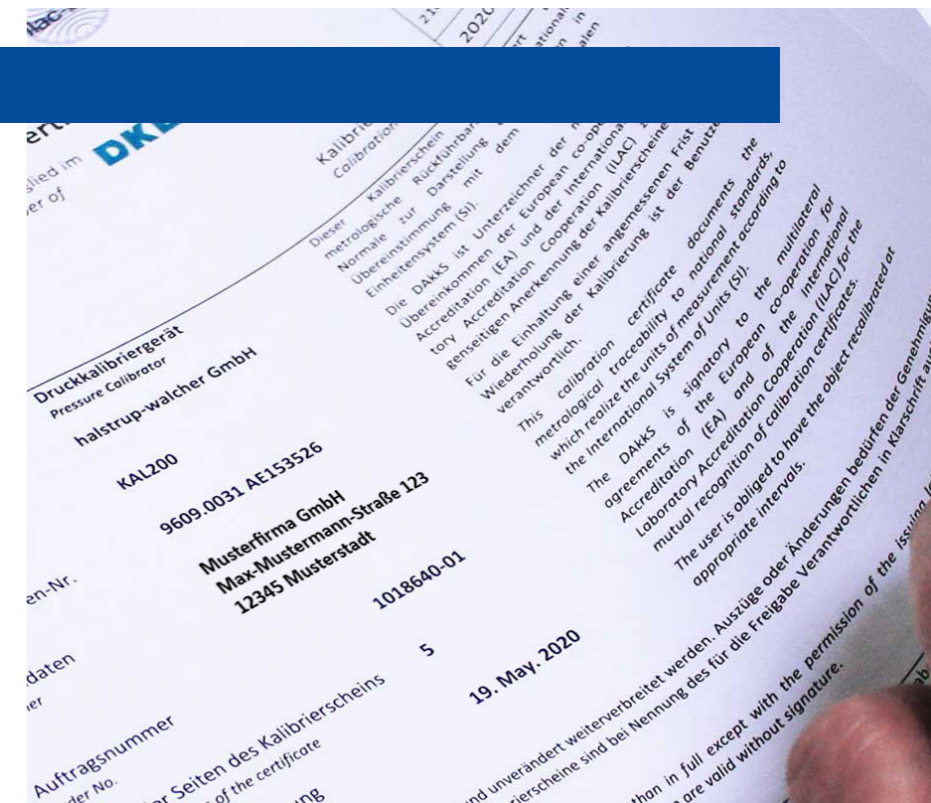



## What we care about

### Focus on the customer and optimal internal processes

As a family-run business, we place a high value on trust and long-term cooperation with our partners. In doing so, it is important to us to develop optimal solutions together with the customer and to be lean internally. We have been living lean management since 2009 and are constantly developing to avoid any waste. In this way, we create optimal economic, technical solutions with maximum customer focus.

We stand for precision, innovation, team spirit and adherence to deadlines. The award of silver in the internationally recognized ecovadis sustainability rating shows that the environment and sustainability are just as important to us as the economic success.



75

With over 75 years of experience, we offer extensive knowledge in drive and measurement technology.

As a family business, we value proximity to our customers. With more than 200 employees, we therefore strive for optimal customer solutions and focus on reliable and long-lasting partnerships.

>200

10%

Innovative and customized products are very important to us. Therefore, about 10% of our workforce works in development and construction.

## Quality management

To provide highest product and service quality, we use different methods to continuously improve our processes. Such as:

- Risk management
- Lean management and
- 8-D reports / NCR (non-compliance-reports)

## Made in Germany

The entire development, production and assembly takes place in Germany. The company headquarters in Kirchzarten near Freiburg is positioned for the future and anchored in the region. Due to the domestic production, you as a customer benefit from fast communication, short decision-making processes and the highest quality standards.





# used in more than **45** countries

halstrup-walcher GmbH  
Stegener Straße 10  
79199 Kirchzarten  
Germany

T. +49 7661 3963-0  
info@halstrup-walcher.de  
www.halstrup-walcher.com