

Bus description

PSD4xx positioning system – CANopen

CANopen



halstrup-walcher GmbH
Stegener Straße 10
79199 Kirchzarten
Germany

Tel. +49 7661 39 63-0
info@halstrup-walcher.com
www.halstrup-walcher.com

© 2024

The manufacturer owns the copyright to this instruction manual. It contains technical data, instructions and drawings detailing the device's features and how to use them. It must not be copied either wholly or in part or made available to third parties.

The instruction manual is part of the product. Please read this manual carefully, follow our instructions, and pay special attention to the safety information provided. This instruction manual should be available at all times. Please contact the manufacturer if you do not understand any part of the instructions.

The manufacturer reserves the right to continue developing this device model without documenting such development in each individual case. The manufacturer will be happy to determine whether this manual is up-to-date.

Table of contents

1	General	4
1.1	Explanation of symbols.....	4
2	Start-up	5
2.1	Set the device address	7
2.2	Set the baud rate	8
2.3	CAN terminating resistor	9
2.4	Switch the device on	10
3	Description of CANopen	11
3.1	Status LEDs.....	11
3.2	Table of entries implemented from object dictionary	12
3.3	Table of device-dependent Min., Max. and Default values	23
3.4	Define PDOs.....	26
3.5	Detailed description of status bits	26
3.6	Detailed description of control bits.....	30
4	Functions	32
4.1	Starting a positioning run	32
4.2	Types of positioning.....	33
4.2.1	Positioning run <i>with</i> loop	33
4.2.2	Positioning run <i>without</i> loop.....	34
4.2.3	Manual run.....	34
4.3	Velocity, acceleration and deceleration.....	35
4.4	Maximum start-up and operating current.....	35
4.5	Behaviour of the drive in case of blocking	36
4.6	Behaviour of the drive if it is turned manually (readjustment function).....	37
4.7	Calculate the absolute physical position	38
4.8	Use of the "Upper mapping end" parameter	42
4.8.1	Delivery state	42
4.8.2	Shifting the positioning range upwards starting from the delivery state 43	
4.8.3	Shifting the positioning range downwards starting from the delivery state 45	
4.8.4	Shifting the positioning range depending on the actual position.....	46
4.8.5	Step-by-step instructions for determining the positioning range.....	48
4.9	Set the spindle pitch.....	50
4.10	Abort the run when the master fails	50
4.11	Reference runs	51
4.12	Run drive in reverse.....	52
5	Technical data	53
6	Notes	54

1 General

This bus description is to be used for the commissioning and integration of the drive into a field bus system.

Technical data for the electrical connections of your drive can be found in the electrical connector and pin assignment description on the website:



www.halstrup-walcher.de/technicaldocu

Please search for "PSD" and select your type, click on "Instruction manuals" and download the "connector and pin assignment" offered for your bus system.

1.1 Explanation of symbols

The device has been designed and tested to ensure its safety. However, it may still be dangerous if used inappropriately. Precautions must be taken to prevent the device being used incorrectly by mistake.

The following warnings are used in this instruction manual:

 DANGER!	DANGER! Indicates a situation of imminent danger, which will lead to a fatality or serious injuries if not prevented.
 WARNING!	WARNING! Indicates a potentially dangerous situation, which may lead to a fatality or serious injuries if not prevented.
 CAUTION!	CAUTION! Indicates a potentially dangerous situation, which may lead to minor/slight injuries if not prevented.
NOTICE	NOTICE Indicates a potentially harmful situation, which may lead to material damage if not prevented.

2 Start-up



WARNING!

Risk of injury if used inappropriately.
The device must be installed by trained technical personnel.



WARNING!

Risk of burns due to hot drive.
The drive can become very hot during operation.
Allow the drive to cool before touching it.



WARNING!

Risk of crushing due to rotary movement.
Do not reach into the working area of the drive when it is still turning.
The user/operator must ensure appropriate protective measures are taken.



WARNING!

Incorrect assembly can lead to the destruction of the drive.



WARNING!

Check that the supply lines are not pinched or crushed.
Lay the supply lines according to the general and specific local assembly regulations.
If the supply lines have not been delivered together with the device, please select suitable cables for the application.
Do not operate the direct drive if the supply lines are noticeably damaged.



WARNING!

Risk of injury. High contact voltages can occur in the case of malfunctions.
This can be prevented by grounding.



CAUTION!

The drive must be protected against excessive heating.
The user/operator must ensure appropriate protective measures are taken.



CAUTION!

Never apply force to the housing of the drive, e.g. for supporting weight.

2.1 Set the device address

You can assign a unique device address using the address switch.

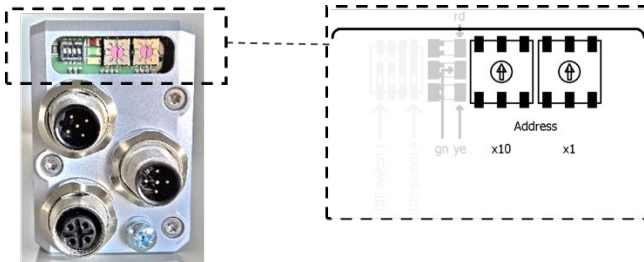

NOTICE

If these address switches are set to 00, the address can be set via the CAN bus with SDO #2026.

The device controls and status elements are located under the sealing plug. You will need a non-conducting pointed object to adjust the switches (e.g. a screwdriver).

Set the tens and units on the respective address switches.

Turn the device off and on again or use the reset command via the control unit to accept the new setting. The device address is now set and the setting is active.

NOTICE

The delivery state is 00; the PSD4xx identifies itself using address 1 at the bus.

NOTICE

If you set the address using the switches (i.e. switches set to > 0) you cannot change this value using the CAN bus.

NOTICE

The yellow LED shows the motor voltage status, the red and green LEDs show the CANopen status.

NOTICE

Always re-attach the protective cap after setting the address. This will prevent dust and contaminants from entering the device.

2.2 Set the baud rate

You can set the baud rate using the sliding switches S2-S4 (DIP switch 2-4).

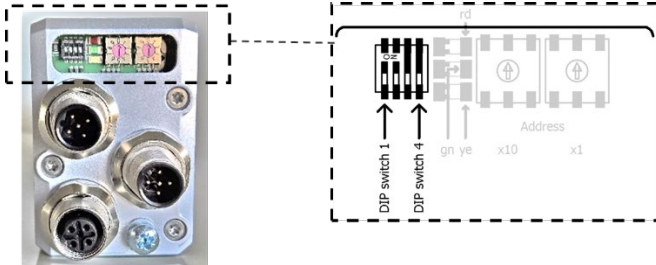

The device controls and status elements are located under the sealing plug. You will need a non-conducting pointed object to adjust the switches.

Please refer to the following table to find the correct baud rate settings and adjust the sliding switches S2-S4 (DIP switch 2-4) accordingly:

Table: Baud rate:

S2	S3	S4	Description
OFF	OFF	OFF	Set baud rate via bus (default = 500 kBaud)
ON	OFF	OFF	20 kBaud
OFF	ON	OFF	50 kBaud
ON	ON	OFF	125 kBaud
OFF	OFF	ON	250 kBaud
ON	OFF	ON	500 kBaud
OFF	ON	ON	800 kBaud
ON	ON	ON	1000 kBaud

Turn the device off and on again or use the reset command via the control unit to accept the new setting.

NOTICE

Maximum bus length	Baud rate
250 m	250 kBaud
100 m	500 kBaud

NOTICE

If the sliding switches S2-S4 are set to OFF, the baud rate is set via the CAN bus with SDO #2027.

NOTICE

If at least one sliding switch S2-S4 is ON, the baud rate cannot be changed via the CAN bus

2.3 CAN terminating resistor

You can use the sliding switch S1 (DIP switch 1) to set the CAN terminating resistor (120 Ω).

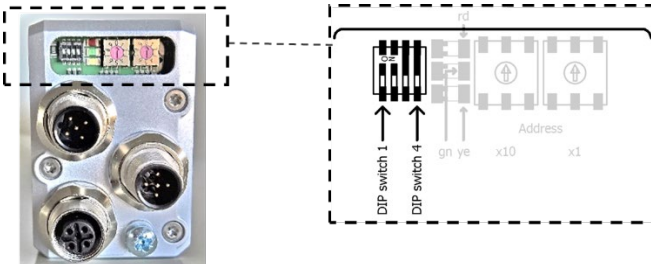

NOTICE

For a line topology, the bus termination is at both ends of the network.

The device controls and status elements are located under the sealing plug. You will need a non-conducting pointed object to adjust the switches (e.g. a screwdriver).

Please refer to the following table for the terminating resistor settings and adjust the sliding switch S1 (DIP switch 1) accordingly:

S1	Description
OFF	Deactivate the terminating resistor
ON	Activate the terminating resistor

2.4 Switch the device on

To turn on the PSD4xx, install the PSD in the correct position according to the assembly instructions. You can find information about installing the drive as well as electrical connections and pin assignments at the following link: www.halstrup-walcher.de/technicaldocu

Please search for “PSD” and select your type, click on “Instruction manuals” and download the “connector and pin assignment” offered for your bus system.

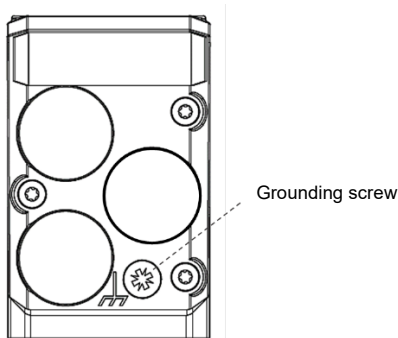

The PSD4xx must be grounded before the power supply cable is connected. The grounding cable must be connected to the correct position on the PSD4xx and to the ground potential (e.g. machine base).

NOTICE

The positioning system should be connected to the machine base using the shortest possible cable. The minimum wire cross-section of the grounding cable is 1.5 mm².

Once the PSD has been grounded, it can be connected to the power supply and the communication interface. The drive is now ready for operation.

3 Description of CANopen

The CAN bus interface uses the CANopen protocol in accordance with CiA DS 301 Version 4.02:

- One transmit and one receive SDO per device
- One asynchronous transmit and receive PDO, active by default
- One heartbeat object every 500 ms

3.1 Status LEDs

The following LEDs are located under the sealing plug:

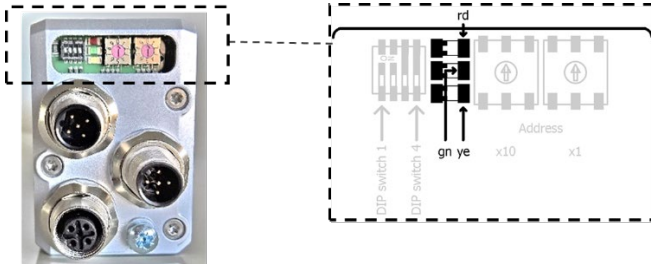

Green LED (gn) = RUN LED in accordance with CANopen:

Single flashes:	CAN stop
Continuous flashing:	CAN preoperational
Continuously illuminated:	CAN operational

Red LED (rd) = ERROR LED in accordance with CANopen:

Single flashes:	CAN-transmitter or -receiver has reached its warning limit
Double flashes:	Guard event has occurred
Triple flashes:	Sync failure
Continuously illuminated:	CAN bus OFF

Yellow LED (ye) = Display actuator voltage:

Off:	Motor voltage too low or too high
On:	Motor voltage OK
Flashing at 0.5 Hz	Motor voltage OK and drive in the delivery state (for parameter values and axle positions)

3.2 Table of entries implemented from object dictionary

Designation	Index no.	Function	Range of values	Back up?	Delivery state	R/W
Device type	1000	Returns a "0" when read	0		0	R
Error register	1001	Bit 0: General error Bit 4: Communication error	8 bit		0	R
Error list	1003	Sub index 0: No. of indices Sub-index 1 and 2: last emergency errors occurred	8 bit 32 bit		0 0	R R
Sync ID	1005	COB ID for the sync command	32 bit	No	80h	R/W
Comm cycle	1006	Communication cycle time	32 bit	No	0	R/W
Sync window	1007	Synchronous window time	32 bit	No	0	R/W
Guard time	100C	Guard time in ms 0 = off	16 bit	No	0	R/W
Lifetime	100D	Lifetime factor	8 bit	No	0	R/W
Emcy ID	1014	COB ID for emergency message	32 bit		80h + device address	R
Emcy inhibit	1015	Inhibit time for emergency message	16 bit	No	0	R/W
Consumer heartbeat	1016	Sub index 0: No. of indices (= 2) Sub index 1 and 2: Bit 15-0: Heartbeat time in ms Bit 23-16: Node ID of producer	8 bit 32 bit		2 0	R R/W
Heartbeat producer	1017	Cycle time for heartbeat via PSD4xx 0 = off	16 bit	No	500	R/W

Description of CANopen

Designation	Index no.	Function	Range of values	Back up?	Delivery state	R/W	
Identity	1018	Sub index 0: No. of indices (= 4)	8 bit		4	R	
		Sub 1: Vendor-ID (= 0x000002D8)	32 bit			R	
		Sub 2: Product code (depends on the device type)	32 bit			R	
		Sub 3: Revision number (= 0)	32 bit			R	
		Sub 4: Serial number (= 0)	32 bit			R	
Receive PDO 1 communication parameter	1400	Sub index 0: No. of indices	8 bit		0	R	
		Sub 1: COB ID of this PDO	32 bit	No		200h + device address	R/W
		Sub 2: PDO type	8 bit	No		0xFF	R/W
Receive PDO 1 mapping	1600	Sub index 0: No. of indices (= 3)	8 bit		3	R	
		Sub 1: 0x20240010	32 bit			R	
		Sub 2: 0x00000010	32 bit			R	
		Sub 3: 0x20010020	32 bit			R	
Transmit PDO 1 communication parameter	1800	Sub index 0: No. of indices	8 bit		0	R	
		Sub 1: COB ID of this PDO	32 bit	No		180h + device address	R/W
		Sub 2: PDO type	8 bit	No		0xFF	R/W
		Sub 3: Inhibit time	16 bit	No		1000 (100 ms)	R/W
		Sub 5: Event time	16 bit	No		0	R/W
Transmit PDO 1 mapping	1A00	Sub index 0: No. of indices (= 3)	8 bit		3	R	
		Sub 1: 0x20250010	32 bit			R	
		Sub 2: 0x20300010	32 bit			R	
		Sub 3: 0x20030020	32 bit			R	
	2000: 0...9	10 general purpose registers	32 bit	Yes	0	R/W	

Designation	Index no.	Function	Range of values	Back up?	Delivery state	R/W
Target value	2001	Target position Value in 1/100 mm (for default values of numerator, SDO #2010 and denominator SDO #2011)	±31 bit	No	0	R/W
Actual value	2003	Current actual position; value in 1/100 mm (for default values of numerator, SDO #2010 and denominator SDO #2011) Writing to this index number causes the current position to be "referenced" to the transferred value	±31 bit	No		R/W
Referencing value	2004	Correction factor for the target, actual and limit switch values	±31 bit	Yes	0	R/W
Positioning window	2006	Permissible difference between target and actual values for the "position reached" bit The maximum setting value changes according to the same factor as the resolution Value range for standard settings of numerator (SDO #2010) and denominator (SDO #2011): 1...100 steps	0.0025 ...0.25 rotations 16 bit	Yes	2	R/W
Actual value assessment, numerator	2010	These values can be used to set a desired user resolution to the drive. For a numerator factor of 400, the spindle pitch/resolution is stated in the denominator factor	1... 10000 16 bit	Yes	400	R/W
Actual value assessment, denominator	2011	e.g.: Spindle pitch 1.5 mm with resolution 1/100 mm: numerator = 400, denominator = 150	1... 10000 16 bit	Yes	400	R/W
Target rpm Posi	2012	Maximum rpm to be used for positioning runs; value in rpm	see chap. 3.3 16 bit	Yes	see chap. 3.3	R/W

Description of CANopen

Designation	Index no.	Function	Range of values	Back up?	Delivery state	R/W
Target rpm Manual	2013	Maximum rpm to be used for manual runs; value in rpm	see chap. 3.3 16 bit	Yes	see chap. 3.3	R/W
Maximum current	2014	Applies after the end of the start-up phase (during start-up phase, the value #2018 applies); value in mA	see chap. 3.3 16 bit	Yes	see chap. 3.3	R/W
Upper limit	2016	Maximum permitted target position Permissible values: (Upper mapping end - 1200 .. 1,611,600 * denominator/numerator) For models with an auxiliary gearbox, the range of values is reduced in accordance with the gear ratio.	±31 bit	Yes	see chap. 3.3	R/W
Lower limit	2017	Minimum permissible target position Permissible values: (Upper mapping end - 1200 .. 1,611,600 * denominator/numerator) For models with an auxiliary gearbox, the range of values is reduced in accordance with the gear ratio.	±31 bit	Yes	See chap. 3.3	R/W
Max. start-up current	2018	Value in mA	See chap. 3.3 16 bit	Yes	See chap. 3.3	R/W
Time period for start-up current	2019	Value in ms	10... 1000 16 bit	Yes	200	R/W
Rpm limit for aborting run	201A	Value in % of the target rpm	30...90 16 bit	yes	30	R/W
Time elapsed until speed falls below rpm limit for aborting run	201B	Value in ms	50...500 16 bit	yes	200	R/W

Designation	Index no.	Function	Range of values	Back up?	Delivery state	R/W
Acceleration	201C	Value in rpm per second	see chap. 3.3 16 bit	Yes	see chap. 3.3	R/W
Deceleration	201D	Value in rpm per second	see chap. 3.3 16 bit	Yes	see chap. 3.3	R/W
Loop length	201F	<p>Minimum number of increments, in which the drive runs to a target in a specified direction.</p> <p>Value in increments (0 → no loop)</p> <p>The sign determines the direction of the loop:</p> <p>Positive → loop to larger values</p> <p>Negative → loop to smaller values</p> <p>Value range for standard settings of numerator (SDO #2010) and denominator (SDO #2011): -4000 .. -10 increments and 10 .. 4000 increments and 0</p>	<p>0.025 ... 10 rotations</p> <p>or</p> <p>-0.025 ... -10 rotations</p> <p>or</p> <p>0</p> <p>±31 bit</p>	Yes	250 increments	R/W

Description of CANopen

Designation	Index no.	Function	Range of values	Back up?	Delivery state	R/W
Control word	2024	Bit 0: Manual run to larger values Bit 1: Manual run to smaller values Bit 2: Transfer target value (During target value transmission using PDOs, the target value is accepted only when this bit is set.) Bit 4: Release: The axle will only run if this bit is set. Bit 6: Run without loop Bit 10: Release readjustment Bit 13: Toggle bit Bit 14: Error Acknowledge (from firmware V3.02) All other bits are reserved and must be set to 0	16 bit	No	0	R/W

Designation	Index no.	Function	Range of values	Back up?	Delivery state	R/W
Status	2025	Bit 0: Target position reached Bit 1: Reserved Bit 2: Toggle bit Bit 3: Reserved Bit 4: Motor power present Bit 5: Positioning run aborted Bit 6: Drive is running Bit 7: Temperature exceeded Bit 8: Movement opposite loop direction Bit 9: Error Bit 10: Positioning error (block) Bit 11: Manual displacement Bit 12: Incorrect target value Bit 13: Motor power was missing Bit 14: Positive range limit Bit 15: Negative range limit	0..FFFFh 16 bit			R
CAN address	2026	Address of the drive (if the address is set via the CAN bus) If the address switches are used (i.e. switch position set to > 0), this value cannot be changed.	1...127 16 bit	Yes	1	R/W
Baud rate	2027	0: 20 kBaud 4: 500 kBaud 1: 50 kBaud 5: 800 kBaud 2: 125 kBaud 6: 1000 kBaud 3: 250 kBaud If the baud rate switch is in use (i.e. switch position not set to OFF-OFF-OFF), this value cannot be changed.	0...6 16 bit	Yes	4	R/W

Description of CANopen

Designation	Index no.	Function	Range of values	Back up?	Delivery state	R/W
Upper mapping end	2028	<p>Definition of the positioning range relative to the absolute value encoder</p> <p>Permissible values: (current position + 3 rotations) ... (current position + 4029 rotations)</p> <p>For models with an auxiliary gearbox, the range of values is reduced in accordance with the gear ratio.</p>	±31 bit	Yes	see chap. 3.3	R/W
Maximum holding current	202B	Holding current at standstill; in mA	see chap. 3.3 16 bit	Yes	see chap. 3.3	R/W
Direction of rotation	202C	<p>0: Clockwise (when looking at the output shaft)</p> <p>1: Counter clockwise</p>	0 or 1 16 bit	Yes	0	R/W
Actual rpm	2030	Current speed; in rpm	±15 bit			R
Max. actual current during last run	2031	Max. actual current during last run; in mA	16 bit			R
Actual current	2033	Actual current; in mA	16 bit			R
U control	203A	Current supply voltage to control unit, in 0.1 V	16 bit			R
U motor	203B	Current supply voltage to motor, in 0.1 V	16 bit			R
UMot limit	203C	Voltage limit for bit "Motor power present" given in increments of 0.1 V	180...240 16 bit	Yes	185	R/W
UMot filter	203D	Average time for measuring UMot voltage; given in steps of 1 ms	100...1000 16 bit	Yes	100	R/W
Temperature limit	203E	Upper temperature limit in °C	10...80 16 bit	Yes	80	R/W
Device temperature	203F	Internal device temperature in °C (accuracy: ± 5 K)	±15 bit			R

Designation	Index no.	Function	Range of values	Back up?	Delivery state	R/W
Production date	2040	Year and week of manufacture (given as an integer)	YYWW 16 bit			R
Serial number	2041	Device serial number	0...65535 16 bit			R
Max. holding current at end of run	2042	Max. holding current at end of run; in mA	see chap. 3.3 16 bit	Yes	see chap. 3.3	R/W
Duration of max. holding current at end of run	2043	Duration of max. holding current at end of run; in ms	0...1000 16 bit	Yes	200	R/W
Device type	204D	One of the following device types from the PSD series (the last 2 digits of the 5-digit numbers refer to the diameter of the output shaft, e.g. 42208 → 8 mm shaft): 40105, 40108, 40114, 40308, 40314, 41105, 41108, 41114, 41308, 41314, 42208, 42214, 42414, 42614, 42814, 43208, 43214, 43414, 43614, 43814, 48005, 48008, 48014, 48108, 48114, 49005, 49008, 49014, 49108, 49114	16 bit			R
Version	204E	Software version number	16 bit			R

Designation	Index no.	Function	Range of values	Back up?	Delivery state	R/W
Delivery state	204F	<p>Writing a “-5”: Resets the drive (corresponds to switching the control voltage off and on again)</p> <p>Writing a “-4”: Resets all parameters to the delivery states (CAN address SDO #2026 to 1, baud rate SDO #2027 to 500 kBaud), without saving the parameters in EEPROM, without a start-up reference loop and without positioning in the middle of the measurement range.</p> <p>Writing a “-3”: Resets all parameters to the delivery states (without changing the CAN address and baud rate), without saving the parameters in EEPROM, without a start-up reference loop and without positioning in the middle of the measurement range.</p> <p>Writing a “-2”: Resets all parameters to the delivery states (CAN address SDO #2026 to 1, baud rate SDO #2027 to 500 kBaud), without saving the parameters in EEPROM. The drive then performs a start-up reference loop and positions itself in the middle of the measurement range.</p> <p><i>Continues on next page</i></p>	-5...-1 or 1 ±15 bit	No		R/W

Designation	Index no.	Function	Range of values	Back up?	Delivery state	R/W
Delivery state		<p>Writing a “-1”: Resets all parameters to the delivery states (without changing the CAN address and baud rate), without saving the parameters in EEPROM. The drive then performs a start-up reference loop and positions itself in the middle of the measurement range.</p> <p>Writing a “1”: Saves the parameter in EEPROM</p> <p>Writing a “0”: No action</p> <p>Reading after booting: 0 → Memory content correct ≠ 0 → Memory content incorrect</p> <p>Reading after saving: 0 → Saving successfully completed ≠ 0 → Saving is not yet complete or terminated with errors (saving can take up to 2000 ms)</p>	-5...-1 or 1 ±15 bit	No		R/W

3.3 Table of device-dependent Min., Max. and Default values

NOTICE

The operating current setting is optimised for the nominal rated speed of the respective device model. The more the set speed deviates from the nominal rated speed (rpm), the greater the actual power consumption deviates from the set current value.

NOTICE

Setting the value for the holding current to 0 results in a maximum current consumption by the motor circuit of approx. 50 mA.

Device type		PSD 401/411 - 5V	PSD 401/411 - 8H/14H	PSD 403/413 - 8H/14H	PSD 422/432 - 8V	PSD 422/432 - 8H/14H
Name	SDO	Range of values Delivery state				
Upper limit *)	2016	- 805,200	- 805,200	- 197,298	- 805,200	- 805,200
Lower limit *)	2017	- -805,200	- -805,200	- -197,298	- -805,200	- -805,200
Target rpm for positioning run	2012	1...800 200	1...500 200	1...250 50	1...1000 200	1...500 200
Target rpm, manual run	2013	1...800 70	1...500 70	1...250 17	1...1000 70	1...500 70
Acceleration	201C	1...5000 1000	1...5000 1000	1...1250 250	1...5000 500	1...5000 500
Deceleration	201D	1...5000 2000	1...5000 2000	1...1250 500	1...5000 2000	1...5000 2000
Max. operating current	2014	5...2000 750	5...2000 750	5...2000 750	5...4000 1500	5...4000 1500
Max. start-up current	2018	5...2000 1000	5...2000 1000	5...2000 1000	5...4000 2000	5...4000 2000
Max. holding current	202B	0...300 30	0...300 30	0...300 30	0...400 40	0...400 40
Upper mapping end *)	2028	- 806,400	- 806,400	- 198,498	- 806,400	- 806,400
Max. holding current at end of run	2042	0...600 60	0...600 60	0...600 60	0...800 80	0...800 80

*) The min. and max. values of the parameter cannot be specified as they depend on the current scaling. The specified default value applies to the standard scaling (400 steps per rotation).

Device type		PSD 424/434 - 14H	PSD 426/436 - 14H	PSD 428/438 - 14H	PSD 480/490 - 5V	PSD 480/490 - 8H/14H
Name	SDO	Range of values Delivery state				
Upper Limit *)	2016	- 387,600	- 254,800	- 195,483	- 805,200	- 805,200
Lower Limit *)	2017	- -387,600	- -254,800	- -195,483	- -805,200	- -805,200
Target rpm for positioning run	2012	1...482 100	1...317 63	1...250 50	1...800 200	1...500 200
Target rpm, manual run	2013	1...482 34	1...317 22	1...250 17	1...800 70	1...500 70
Acceleration	201C	1...2411 240	1...1587 150	1...1250 125	1...5000 1000	1...5000 1000
Deceleration	201D	1...2411 960	1...1587 635	1...1250 500	1...5000 2000	1...5000 2000
Max. operating current	2014	5...4000 1500	5...4000 1500	5...4000 1500	5...1900 712	5...1900 712
Max. start-up current	2018	5...4000 2000	5...4000 2000	5...4000 2000	5...1900 950	5...1900 950
Max. holding current	202B	0...400 40	0...400 40	0...400 40	0...250 25	0...250 25
Upper mapping end *)	2028	- 388,800	- 256,000	- 196,683	- 806,400	- 806,400
Max. holding current at end of run	2042	0...800 80	0...800 80	0...800 80	0...500 50	0...500 50

*) The min. and max. values of the parameter cannot be specified as they depend on the current scaling. The specified default value applies to the standard scaling (400 steps per rotation).

Description of CANopen

Device type		PSD 481/491 - 8H/14H
Name	SDO	Range of values Delivery state
Upper Limit *)	2016	- 197.298
Lower Limit *)	2017	- -197.298
Target rpm for positioning run	2012	1...250 50
Target rpm, manual run	2013	1...250 17
Acceleration	201C	1...1250 250
Deceleration	201D	1...1250 500
Max. operating current	2014	5...1900 712
Max. start-up current	2018	5...1900 950
Max. holding current	202B	0...250 25
Upper mapping end *)	2028	- 198.498
Max. holding current at end of run	2042	0...500 50

*) The min. and max. values of the parameter cannot be specified as they depend on the current scaling. The specified default value applies to the standard scaling (400 steps per rotation).

3.4 Define PDOs

1) Receive PDO (from the perspective of the PSD4xx)

Address: 200h + CAN address (possible values: 201h...27Fh)

Assignment (cannot be modified):

Bit	Byte	Meaning	Corresponding SDO index number
0-15	0, 1	Control word	2024h
16-31	2, 3	Unused	
32-63	4-7	Target value	2001h

2) Transmit PDO (from the perspective of the PSD4xx)

Address: 180h + CAN address (possible values: 181h...1FFh)

Assignment (cannot be modified):

Bit	Byte	Meaning	Corresponding SDO index number
0-15	0, 1	Status	2025h
16-31	2, 3	Current rpm	2030h
32-63	4-7	Actual value	2003h

3.5 Detailed description of status bits

Bit 0 Target position reached

This bit is set:

- when a transferred target position has been reached successfully
- after running a start-up reference loop, when the actual value corresponds to the previously transferred target value
- after manual displacement while at standstill, if readjustment is activated and the absolute value of the difference of actual and target value is smaller or equal to the positioning window again.

This bit is reset:

- after transferring a target position if the release bit is set and when the difference from the actual value is larger than the positioning window (SDO #2006)
- by a manual run
- if an invalid target value has been transferred
- as a result of manual rotation when not in operation

Bit 1 Reserved

Description of CANopen

Bit 2 Toggle bit

This bit is set:

- when bit 13 of the control word is set

This bit is reset:

- when bit 13 of the control word is reset

Bit 3 Reserved

Bit 4 Motor power present

This bit is set:

- if the supply voltage for the motor is above the UMot limit (SDO #203C) and below 30 V

This bit is reset:

- if the supply voltage for the motor is below the UMot limit or above 30 V

Bit 5 Positioning run aborted

This bit is set:

- if a positioning run is aborted because the release has been withdrawn in the control word

This bit is reset:

- when a new run command is transmitted
- with a 0 → 1 edge of the bit "Error Acknowledge" (from firmware V3.02)

Bit 6 Drive is running

This bit is set:

- when the drive is rotating

This bit is reset:

- when the drive is at a standstill

Bit 7 Temperature exceeded

This bit is set:

- when the internal device temperature exceeds the limit specified in SDO #203E

This bit is reset:

- when the internal device temperature falls below the limit value by 5 °C

Bit 8 Movement opposite loop direction

This bit is set:

- after power up or a reset command (any backlash in the driven spindle is not yet eliminated)
- during manual runs in the direction opposite that of the positioning run (a subsequent manual run in the direction of the positioning run will no longer delete this bit)
- during a positioning sequence in the direction opposite to that of the loop direction

This bit is reset:

- when a transferred target position has been reached successfully (in the direction of the loop)
- after the start-up reference loop

Bit 9 Error bit

This bit is set:

- if an unrecoverable error in flash memory occurred
- when an internal problem is detected when calculating the position

No more run commands may be transmitted when the error bit is set!

This bit is reset:

- only by resetting the drive (reset command or switching off and on again)

Bit 10 Positioning error (block)

This bit is set:

- if a positioning run is aborted because the device is overloaded (obstructions, extreme difficulty running)

This bit is reset:

- by transmitting a new positioning command
- after a start-up reference loop has been correctly executed
- with a 0 → 1 edge of the bit "Error Acknowledge" (from firmware V3.02)

Bit 11 Manual displacement

This bit is set:

- if, while at a standstill, the drive is rotated externally by more than the value in the positioning window

This bit is reset:

- by transmitting a new positioning command
- after a start-up reference loop has been correctly executed
- with a 0 → 1 edge of the bit "Error Acknowledge" (from firmware V3.02)

Bit 12 Incorrect target value

This bit is set:

- if a transferred target value lies outside the range of the limit switches, caused e.g. by the current referencing value (SDO #2004)
- if a transferred target value lies within the range of the limit switches, but would leave the specified range during the required loop

This bit is reset:

- by transmitting a valid target value
- with a 0 → 1 edge of the bit "Error Acknowledge" (from firmware V3.02)

Bit 13 Motor power was missing

This bit is set:

- if the motor voltage is less than the UMot limit (SDO #203C) or above 30 V when initiating a positioning run or start-up reference loop
- if the motor voltage leaves the specified range during the run

This bit is reset:

- if the motor voltage is greater than the UMot limit and under 30 V when initiating a positioning run or start-up reference loop
- with a 0 → 1 edge of the bit "Error Acknowledge" (from firmware V3.02)

**Bit 14/
Bit 15 Forward/reverse limit reached**

This bit is set:

- if the limit value is reached during a manual run(not when reached during a positioning run)
- if an end limit is modified such that the current position lies beyond it
- if, when at a standstill, the drive is moved to a position beyond the range defined by the end limit by an external force

This bit is reset:

- when the actual position is again within the positioning range limits (exception: after completing a manual run, the drive is at the range limit, still within the positioning window and a new run command has not yet been issued)

3.6 Detailed description of control bits

Bit 0 **Manual run to larger values**

Bit 1 **Manual run to smaller values**

Bit 2 **Transfer target value**

During target value transmission using PDOs, the target value sent in the same PDO is accepted as the new valid target value when this bit is set. A positioning run that starts simultaneously or later uses this target value as the new target position. If a positioning is to be started immediately together with the acceptance of the target value, bit 4 (“release”) must be set simultaneously in addition to bit 2.

If bit 2 is not set, the target value is not accepted; instead, by setting the release bit, a positioning run can be carried out to the target value last transferred and marked as valid.

Bit 3 **Reserved**

must be set to 0

Bit 4 **Release**

Run commands will only be executed if this bit is set. This bit must be set for positioning runs and manual runs. If this bit is reset during a run, the run will be aborted and status bit 5 (“Positioning run aborted”) will be set.

If bit 2 is not set, the target value is not accepted; instead, by setting the release bit, a positioning run can be carried out to the target value last transferred and marked as valid.

Bit 5 **Reserved**

must be set to 0

Bit 6 **Run without loop**

If this bit is set during positioning runs, all target positions will be approached directly (independently of the current value in SDO #201F) without any loop.

Bit 7-9 **Reserved**

must be set to 0

Bit 10: **Release readjustment**

If the drive is rotated in the direction opposite to that of the loop direction, it readjusts its position only if this bit is set. If the loop length (SDO #201F) is set to 0, the drive readjusts in both directions.

Bit 11-12: **Reserved**

must be set to 0

Description of CANopen

Bit 13: Toggle bit

Always when a control word is received, the drive writes the value of this bit in status word bit 2.

→ The control unit can recognize when new process data are processed by the drive.

Bit 14: Error Acknowledge

With a 0 → 1 edge of this bit, the error bits 1, 5, 10, 11, 12 and 13 in the status byte are acknowledged (from firmware V3.02)

Bit 15: Reserved

must be set to 0

4 Functions

4.1 Starting a positioning run

To control the drive with PDOs it must first be switched to the CANopen state "operational". A positioning movement is then started as follows:

- Transfer target value:
 PDO with target value and control word = 0014h or
 target value on SDO #2001 and control word = 10h on SDO #2024
 → drive begins run
- Stop operation by removing the release (transmit PDO with control word = 0000h or SDO #2024 with value 0000h)

NOTICE

If a new target value needs to be set during an active positioning run, the drive must be stopped (reset the release bit). The new target value can be set when the drive is at a standstill.

NOTICE

If a manual run is required during an active positioning run, the drive must be stopped (reset the release bit). The manual run can be started when the drive is at a standstill.

The following sequence of steps is also possible:

Starting condition:

- release has not been set
- Target value has already been transferred
 (in case of PDO transfer the release in the control word was not set already).

Set release → drive begins run

NOTICE

Positioning runs may include a "loop run", which causes the target to be approached from a defined direction. The direction and length of the loop run can be set to the desired value with SDO #201F ("loop length") before the positioning run begins. SDO #201F can also be used to deactivate the loop run.

4.2 Types of positioning

4.2.1 Positioning run *with loop*

The PSD4xx distinguishes between the following cases of a positioning sequence (Assumption: the target position is always approached through forward motion)

- 1) New position value is larger than the current value:
position approached directly.

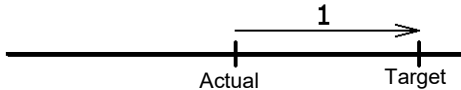

- 2) New position value is smaller than the current value:
the drive reverses an additional 5/8 of one rotation (2a)
and approaches the exact position after resuming forward motion (2b)

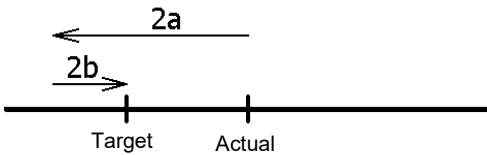

- 3) New position value after reverse run (no loop):
the drive always approaches by moving forward (3b),
if necessary, it will first reverse by 5/8 of a rotation (3a).

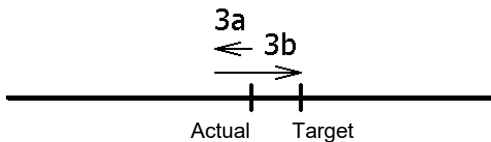

After reaching the target position, this position is compared with the internal absolute encoder position. If the deviation is more than 0.9° (at the motor shaft) a second positioning is automatically started and the drive will move to the target position again. If there is another deviation of more than 0.9°, the status bit "Positioning error (block)" is set.

NOTICE

It is not possible to perform a positioning run to the upper limit (SDO #2016) with a loop length < 0 because the drive would have to run past the upper limit in order to do so. The same applies to the lower limit (SDO #2017) with loop length > 0.

4.2.2 Positioning run *without* loop

The “positioning without a loop” mode is used primarily for moving the small distances involved in fine adjustments. In this case, each position is approached directly.

NOTICE

To perform a positioning run without a loop run, in addition to setting the release (bit 4 in the command byte), you must also set bit 6 (“Run without loop”) or SDO #201F (“loop length”) must have the value 0.

NOTICE

In this mode any backlash that might be produced by the driven spindle is NOT eliminated. For models with an integrated auxiliary gearbox, in this case also the internal gear backlash does influence the positioning accuracy.

4.2.3 Manual run

The drive can be operated manually, the so-called manual run. This helps to simplify commissioning.

Start manual run:

The manual run begins when the manual run control word is transferred (control word = 0x11 or 0x12).

End manual run:

When a corresponding control word is transferred the manual run is stopped. Possible are the reset of the manual run command (control word = 0x10) or the reset of the release bit by the control word (control word = 0x00).

NOTICE

If a positioning run is required during an active manual run, the drive must be stopped (reset the release bit). The positioning run can be initiated as soon as the drive is at standstill (control word = 0x14 and the desired target value).

4.3 Velocity, acceleration and deceleration

Start-up reference loops and manual runs are performed at the maximum velocity from SDO #2013.

Positioning runs are performed at the maximum velocity from SDO #2012.

For all runs, the maximum acceleration from SDO #201C and the maximum deceleration from SDO #201D apply.

NOTICE

If during a run the release bit in the control word is cleared or the target position is approached, the deceleration is carried out with the parameter "deceleration" (SDO #201D). If the speed is increased or decreased during a run, the parameter "acceleration" is used (SDO #201C).

4.4 Maximum start-up and operating current

The maximum start-up current can be set via SDO #2018, the maximum operating current can be set via SDO #2014.

The start-up current is active after each run begins for the period defined in SDO #2019.

NOTICE

The start-up current should always be slightly higher than the operating current because the drive requires more power during the acceleration phase than when running at a constant speed.

NOTICE

If small torque limits are to be used, the following must be considered: Small operating torque values should not be used in combination with high speed settings as this can lead to instable positioning behaviour!

4.5 Behaviour of the drive in case of blocking

If, during the run, the achievable speed falls below the limit value of 30 % of the selected maximum speed (SDO #201A) for longer than 200 ms (SDO #201B) (these are the default values), the device registers an obstruction, aborts the run and sets the "Positioning error" bit. The drive then comes to a standstill with the selected holding torque (SDO #202B).

After this, new run commands can be sent without taking further measures, i.e. transferring a new target position starts a new positioning run.

An exception is when the target value is the same as before. In this case, the release bit must first be cleared and then set again (bit 4 in the control word). The drive then continues to run when the release bit is set. Bit 2 ("Transfer target value") must also be set.



CAUTION!

Runs which intentionally involve a run to an obstruction (e.g. reference runs to a block) may only be started with a reduced current (max. operating current < 10 % of nominal rated current or smallest possible value).

4.6 Behaviour of the drive if it is turned manually (readjustment function)

If the PSD4xx is rotated in the direction opposite to that of the loop direction – when at a standstill, after a correctly completed positioning run and the release bit (bit 4 in the control word) as well as the readjustment bit (bit 10) are activated – it will again attempt to run to the previously sent target value (readjustment). After successful readjustment bit 0 will be set again.

NOTICE

The device does not attempt to readjust if rotated in the direction to that of the loop direction, it will merely set bit 11 of the status word (“Manual displacement”) and reset bit 0 (“Target position reached”). If the loop length (SDO #201F) is set to 0, the drive readjusts in both directions.

NOTICE

If the drive continually loses its position when at a standstill, it will attempt to readjust whenever its actual position just leaves the positioning window (provided that all of the above-mentioned conditions are met). At this time, the motor voltage must be within the permissible range (i.e. bit 4 in the status word is set).

No readjustment will start if the motor voltage is not in the permissible range. Instead, bits 10 (“Positioning error”) and 13 (“Motor power was missing”) will be activated.

If the motor voltage only returns to the permissible range after leaving the positioning window, no new readjustment attempt will start. This prevents a situation in which the drive suddenly starts to move when the motor voltage is switched on.

If a positioning run or manual run is aborted while in progress by a stop command (“Release” bit in control word to 0), the drive will only readjust when a new run command is sent and completed correctly.

Resetting the release bit and/or the bit “Release readjustment” can completely prevent the readjustment process.

4.7 Calculate the absolute physical position

The PSD4xx actuator includes an absolute measuring system capable of covering a range of 4,026 rotations. This allows the user to determine the direction of rotation for any desired portion of these 4,026 rotations.

The mapping of the desired positioning range to the physical positioning range "mapping end" is performed via SDO #2028.

NOTICE

The following explanations concern the variants without auxiliary gearbox. For variants with auxiliary gearbox, the specified numerical values are reduced accordingly.

When it is delivered, the drive is positioned at 0, the upper limit switch is positioned at 805,200, the lower limit switch positioned at -805,200. This results in a positioning range of $\pm 2,013$ rotations ($\pm 805,200$ steps). If the desired positioning range does not exceed $\pm 2,013$ rotations, none of the steps described below are required to set the positioning range in the delivery state.

The following two options are available to allow you to realise any desired positioning run distances independently of the run distance set by the mounting orientation of the measurement system (physical positioning range):

- 1) Bring the axle to be moved (e.g. a spindle) into the desired position, run the drive to the appropriate position with the adjustable collar open and only then close the adjustable collar.

Examples:

- a) Bring the axle to be positioned into the mid-position, run the drive in neutral (with the adjustable collar open) to the mid-position (position 0), then close the adjustable collar. The drive can now run 2,013 rotations in both directions (default $\pm 805,200$ increments).
 - b) Bring the axle to be positioned all the way to the left (or bottom), run the drive in neutral (with the adjustable collar open) without a loop to the smallest position (position -805,200), then close the adjustable collar. The drive can now run 4,026 rotations to the right (or top) (default 1,610,400 increments).
 - c) Bring the axle to be positioned all the way to the right (or top), run the drive in neutral (with the adjustable collar open) to the largest position (position 805,200), then close the adjustable collar. The drive can now run 4,026 rotations to the left (or bottom) (default 1,610,400 increments).
- 2) Mount the drive in the required position on the axle, close the adjustable collar, then adjust the positioning range using SDO #2028. SDO #2028 sets the upper end of the positioning range. Default setting: upper end at +2016 rotations (position 806,400). If, after mounting the drive, the positioning range does not match the currently displayed position, you can select the positioning range between +3 rotations and +4,029 rotations (measured from the current position) as required.

Examples:

Functions

- a) After mounting the drive, the position 0 is displayed (which corresponds to the delivery state). The positioning range should point exclusively to the right (or top)
 - Upper mapping end = position + 4,029 rotations
 - Set SDO #2028 to 1,611,600
- b) After assembly, the displayed position is 804,000. However, the positioning range should point exclusively to the right (or top)
 - Upper mapping end = position + 4,029 rotations
 - Set SDO #2028 to 2,415,600
- c) After assembly, the displayed position is -804,400. However, the positioning range should point exclusively to the left (or bottom)
 - Upper mapping end = position + 3 rotations
 - Set SDO #2028 to -803,200

Notes:

- 1) When calculating the upper mapping end (SDO #2028) (as in the above examples), it is essential to include a safety margin of 3 rotations (by default 1,200 increments), because the highest possible position value is 3 rotations below the upper mapping end. The smallest possible position value is 4,029 rotations below the upper mapping end.

- 2) The numbers of increments or position values indicated relate to the following settings, which correspond to the delivery state:
 - a) Referencing value (SDO #2004) = 0
 - b) Actual value of numerator (SDO #2010) = 400
 - c) Actual value of denominator (SDO #2011) = 400

These 3 SDOs affect the above numbers of increments or position values: The referencing value can be used to shift the range of values, the numerator/denominator to stretch or extend the range of values (see below).

- 3) If the direction of rotation (SDO #202C) is changed, the referencing value (SDO #2004), the upper mapping end (SDO #2028) and the upper and lower limit switches (SDO #2016 and #2017) will be reset to the delivery states.
- 4) If the upper mapping end (SDO #2028) is changed, the upper and lower limit switches (SDO #2016 and #2017) will be reset to the delivery states.
- 5) If the actual value assessment (numerator: SDO #2010 or denominator: SDO #2011) is changed, the target value, actual value, referencing value, upper mapping end, upper and lower limit switches, positioning window and loop length will be recalculated.
- 6) If the referencing value (SDO #2004) is changed, the target value, actual value, upper mapping end and the upper and lower limit switches will be recalculated.
- 7) If the user wants to avoid any automatic adjustment of values when setting the parameters for the drive, the optimum order for sending the parameters is as follows:
 - a) Direction of rotation (SDO #202C),
actual value assessment of numerator (SDO #2010),
actual value assessment of denominator (SDO #2011)
 - b) Referencing value (SDO #2004)
 - c) Upper mapping end (SDO #2028)
 - d) Upper limit switch (SDO #2016),
Lower limit switch (SDO #2017),
positioning window (SDO #2006),
loop length (SDO #201F)
- 8) To save the settings permanently in EEPROM write a 1 in SDO #204F. As soon as reading SDO #204F returns a 0, the settings have been saved.

Referencing value (SDO #2004):

With the referencing value (SDO #2004) a shift of the entire value range can be achieved. The referencing process affects all transferred values, i.e., the target value, actual value, upper mapping end and upper and lower limit switches.

There are two ways of setting the referencing value:

- 1) Directly – by writing the referencing value in SDO #2004.
- 2) Indirectly – by writing an actual value to SDO #2003. This makes it possible to assign any “true” actual value to the current, physical actual value. The resulting difference is then the referencing value. This value will immediately be included in calculations for each transferred value and can also be read under SDO #2004.

If the referencing value is changed, the target value, actual value, upper mapping end and the upper and lower limit switches will be recalculated.

NOTICE

Removal of the supply voltage to the **motor** has no effect on the internal measurement system.

4.8 Use of the “Upper mapping end” parameter

The following chapter illustrates the use of the parameter “upper mapping end” both graphically and by means of examples:

4.8.1 Delivery state

In the delivery state (“DS”), the actual position is exactly in the middle of the positioning range. There is a safety margin of three rotations at the output shaft at both the lower and upper ends of the positioning range.

Positioning runs that extend into these safety margins are rejected by the device with the error “Incorrect target value”.

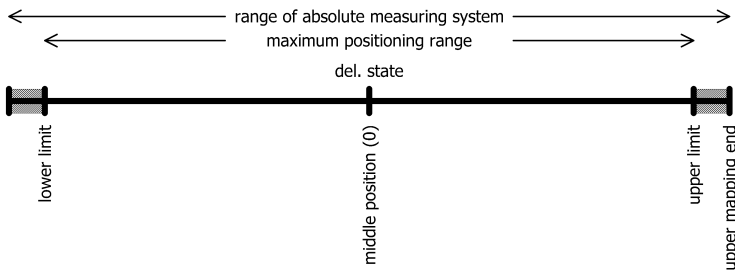

In the delivery state, the values from the following table result for the upper mapping end and the lower and upper limits:

Device type	PSD 401/411, 422/432, 480/490	PSD 403/413, 481/491	PSD 424/434	PSD 426/436	PSD 428/438
Measurement range of the absolute measuring system	4,032 rotations	992 rotations	1,944 rotations	1,280 rotations	983 rotations
Max. possible positioning range	4,026 rotations	986 rotations	1,938 rotations	1,274 rotations	977 rotations
Upper mapping end	806,400	198,498	388,800	256,000	196,683
Lower limit	-805,200	-197,298	-387,600	-254,800	-195,483
Upper limit	805,200	197,298	387,600	254,800	195,483

Positioning range symmetrical to 0

Starting from this state, the maximum possible positioning range can now be shifted upwards or downwards as required.

It is important to note that after the device has been installed, the available positioning range may not be sufficient in one of the two directions. The parameter “upper mapping end” now allows you to reduce the positioning range in one direction and increase it in the other direction.

4.8.2 Shifting the positioning range upwards starting from the delivery state

In the following example, starting from the DS, the maximum possible positioning range is shifted slightly **upwards** using the parameter “upper mapping end” (example for a PSD401/411, PSD422/432 or PSD480/490):

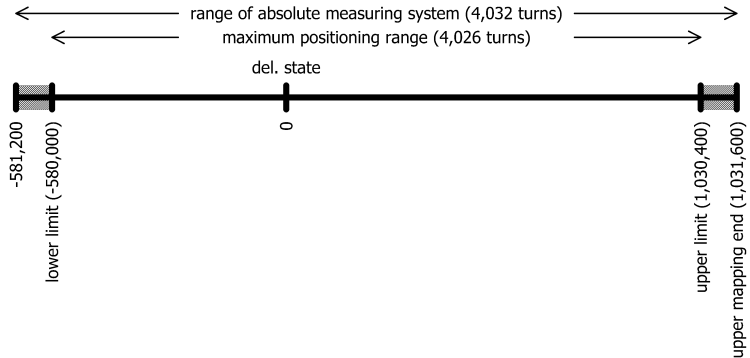

Here, the upper mapping end was increased from the value 806,400 to 1,031,600. Consequently, a higher proportion of the possible positioning range is in the positive range and a smaller proportion in the negative range.

In the extreme case, the upper mapping end can be set so that the entire possible positioning range is at values ≥ 0 . With standard scaling (numerator = denominator = 400, i.e. 1 step = 0.9°) and referencing value = 0, this special case results if the relevant value from the following table is selected for the upper mapping end. The device then automatically adjusts the lower and upper limits accordingly.

Device type	PSD 401/411, 422/432, 480/490	PSD 403/413, 481/491	PSD 424/434	PSD 426/436	PSD 428/438
Measurement range of the absolute measuring system	4,032 rotations	992 rotations	1,944 rotations	1,280 rotations	983 rotations
Max. possible positioning range	4,026 rotations	986 rotations	1,938 rotations	1,274 rotations	977 rotations
Upper mapping end	1,611,600	395,796	776,400	510,800	392,166
Lower limit	0	0	0	0	0
Upper limit	1,610,400	394,596	775,200	509,600	390,966

Positioning range **starts** at 0

Illustration of this extreme case for a PSD401/411, PSD422/432 or PSD480/490:

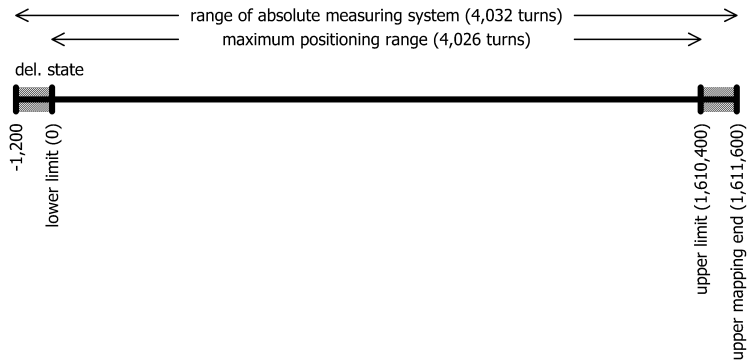

NOTICE

The numerator factor and denominator factor can be used to map any spindle resolutions. Using the referencing value, you can shift the whole range of values.

4.8.3 Shifting the positioning range downwards starting from the delivery state

In the following example, starting from the DS, the maximum possible positioning range is shifted slightly **downwards** using the parameter “upper mapping end” (example for a PSD401/411, PSD422/432 or PSD480/490):

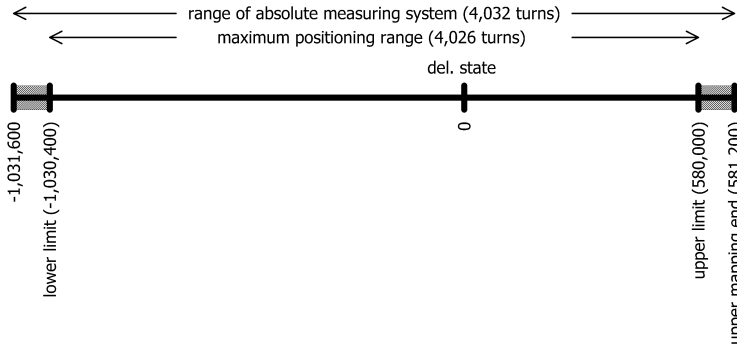

Here, the upper mapping end was decreased from the value 806,400 to 581,200. Consequently, a higher proportion of the possible positioning range is in the negative range and a smaller proportion in the positive range.

In the extreme case, the upper mapping end can be set so that the entire possible positioning range is at values ≤ 0 . With standard scaling (numerator = denominator = 400, i.e. 1 step = 0.9°) and referencing value = 0, this special case results if the relevant value from the following table is selected for the upper mapping end. The device then automatically adjusts the lower and upper limits accordingly.

Device type	PSD 401/411, 422/432, 480/490	PSD 403/413, 481/491	PSD 424/434	PSD 426/436	PSD 428/438
Measurement range of the absolute measuring system	4,032 rotations	992 rotations	1,944 rotations	1,280 rotations	983 rotations
Max. possible positioning range	4,026 rotations	986 rotations	1,938 rotations	1,274 rotations	977 rotations
Upper mapping end	1,200	1,200	1,200	1,200	1,200
Lower limit	-1,610,400	-394,596	-775,200	-509,600	-390,966
Upper limit	0	0	0	0	0

Positioning range ends at 0

Illustration of this extreme case for a PSD401/411, PSD422/432 or PSD480/490:

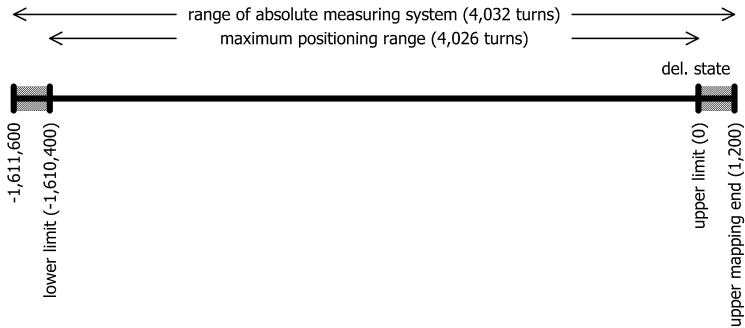

4.8.4 Shifting the positioning range depending on the actual position

If (in contrast to the examples above) the actual position is not in the delivery state (i.e. value 0), this is included in the calculation of the possible value range for the upper mapping end. The decisive factor is that the device only accepts values for the upper mapping end where the actual position is within the max. possible positioning range after the upper mapping end has been set (due to rounding effects with a max. difference of 1 step), i.e. the following applies after setting the upper mapping end:

$$[lower\ limit - 1] \leq actual\ position \leq [upper\ limit + 1]$$

Please note that the measurement range of the absolute encoder is 4,032 rotations at the motor shaft. Depending on the ratio of the auxiliary gearbox, the measurement range at the output shaft is reduced accordingly. Together with the safety margins at the upper and lower end of the measurement range, the following value ranges result for the upper mapping end:

$$\begin{aligned} Minimum\ value\ for\ upper\ mapping\ end &= actual\ position + 1200 * denominator / numerator \\ Maximum\ value\ for\ upper\ mapping\ end &= actual\ position + a * denominator / numerator \end{aligned}$$

The variable *a* differs between the individual device variants:

Device type	PSD 401/411, 422/432, 480/490	PSD 403/413, 481/491	PSD 424/434	PSD 426/436	PSD 428/438
Variable <i>a</i>	1,611,600	395,797	776,400	510,800	392,166

The following formulas result for the special case numerator = denominator:

$$\begin{aligned} Minimum\ value\ for\ upper\ mapping\ end &= actual\ position + 1200 \\ Maximum\ value\ for\ upper\ mapping\ end &= actual\ position + a \end{aligned}$$

(This is the case, e.g. for the delivery state where numerator = denominator = 400.)

NOTICE

Since the upper mapping end is an integer, the minimum and maximum values are obtained by rounding to the nearest integer (applies only to the case numerator \neq denominator).

Example:

- Spindle with 5 mm pitch, specified unit for target and actual values: 1 μm
 → 1 rotation = 5 mm = 5,000 μm
 → Number of steps per rotation = 5,000
- Using the formula
 *Number of steps per rotation = 400 * denominator / numerator*
 the following result is obtained:
 numerator = 400; denominator = 5,000
- With these settings, the drive is mounted and run using manual positioning commands, to a defined physical position (e.g. a specific mark along the run path) at which the actual position is to assume a specific value, e.g. the value 0.
- In our case, the position after running to this defined physical position shows, for example, the value 300,000. In this position, the actual value is set to zero. The device uses this information to calculate the new referencing value at 300,000.
 → Referencing value = 300,000
- The drive (in our case a PSD401, PSD411, PSD422, PSD432, PSD480 or PSD490) has a positioning range of 4,026 rotations (see above: Measurement range of the absolute encoder minus a safety margin of three rotations at both ends of the measurement range).
- In our case, these 4,026 rotations are to be divided in such a way that the drive can run 10 rotations (= 10 * 5,000 steps = 50,000 steps) from the zero position, just defined, to smaller values and 4,016 rotations (= 4,016 * 5,000 steps = 20,080,000 steps) to larger values.
- To ensure that the position value 20,080,000 is at the upper end of the maximum possible positioning range, as specified (i.e. at the upper limit), we add the safety margin of three rotations to this value and thus obtain our value for the upper mapping end:
 upper mapping end = 20,080,000 + 3 * 5,000 = 20,095,000
- The device then recalculates the positioning range limits:
 lower limit = upper mapping end - 4,029 * 5,000 = -50,000
 upper limit = upper mapping end - 3 * 5,000 = 20,080,000
- This positioning range can then be restricted as required, i.e. the lower limit can be increased and the upper limit can be reduced.

4.8.5 Step-by-step instructions for determining the positioning range

The following section describes the procedure for determining those parameters that have an influence on the target and actual position as well as the positioning range.

The individual steps must be carried out in the specified order.

a) Setting the direction of rotation:

The direction of rotation determines with which direction of rotation of the output shaft the position values increase and with which direction of rotation of the output shaft the position values decrease.

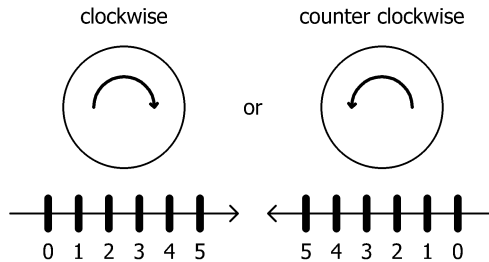

b) Setting numerator and denominator:

The numerator and denominator determine the number of steps into which one rotation of the output shaft is divided.

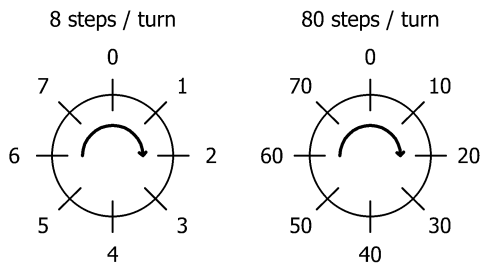

Functions

c) Setting referencing value:

The referencing value is used to assign a specific value of the actual position to a specific physical position of the axle.

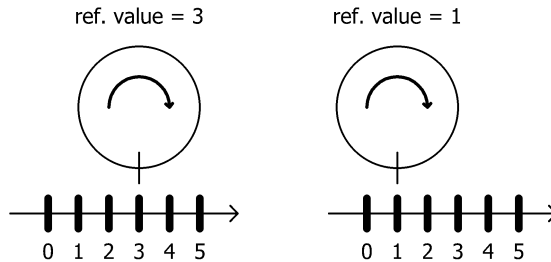

The referencing value is written either directly or by setting the actual position.

d) Setting upper mapping end:

The parameter defines the location of the maximum possible positioning range in relation to the actual position.

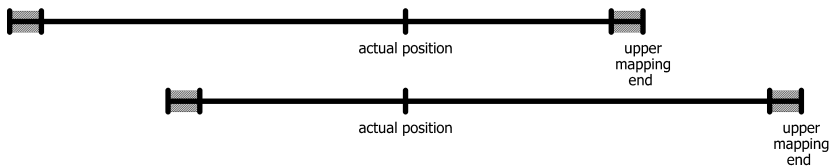

e) Setting upper and lower limits:

If necessary, the maximum possible positioning range can be restricted to prevent incorrect target positions that lead to a collision.

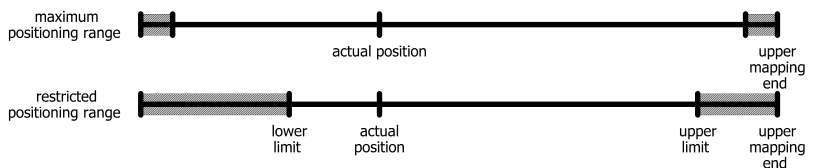

4.9 Set the spindle pitch

SDO #2010 (numerator factor) and #2011 (denominator factor) can be used to set any spindle resolutions using actual value assessment factors.

$$\text{Number of increments per rotation} = 400 \times \frac{\text{Denominator factor}}{\text{Numerator factor}}$$

Both factors are set to a value of 400 by default, resulting in a resolution of 0.01 mm at a spindle pitch of 4 mm.

The denominator factor serves as a simple means of setting the spindle pitch and resolution. The numerator factor is primarily used for setting “unlevel” resolutions.

Examples:

Spindle pitch	Resolution	Numerator factor	Denominator factor
4 mm	1/100 mm	400	400
1 mm	1/100 mm	400	100
2 mm	1/10 mm	400	20

NOTICE

Numerator and denominator factors may take on values between 1 and 10,000

4.10 Abort the run when the master fails

If the connection to the master is interrupted during a positioning run, the master cannot abort a run that is already underway. There are two ways of generating an automatic run abort in a case like this:

- 1) Node guarding or
- 2) Heartbeat consumer

Node guarding

In the case of the former (node guarding), the guard-time and lifetime factors must be programmed into the drive. The master must then cyclically transmit the drive heartbeat as a remote object.

Heartbeat consumer

In the latter method, the Node ID and the cycle time of the master heartbeat must be programmed in the drive as the consumer heartbeat. The master must then send this heartbeat in a cycle.

NOTICE

The second option places less load on the bus, because all drives only need to transmit an unconfirmed master heartbeat (just one message for all consumers).

4.11 Reference runs

The PSD4xx positioning system is equipped with an absolute measuring system, so no reference run is required when the drive is switched on. If a reference run should be required to a hard obstruction in a specific instance (e.g. once during installation of the drive on a machine), the procedure should be as follows:

- 1) Prior to ordering the reference run, adjust the settings as follows:
 - a) Set the max. current (SDO #2014) and max. start-up current (SDO #2018) up to a maximum of 10 % of the nominal rated current, resp. the lowest possible values
 - b) Set the holding current (SDO #202B) and max. holding current at end of run (SDO #2042) to 0
 - c) Set the speed limit (rpm) for run abort (SDO #201A) to 60
 - d) Set the time for falling below the speed limit (rpm) for run abort (SDO #201B) to 100 (The time during which the drive tries to overcome the obstruction decreases: with these reduced values, the positioning run is aborted if the speed (rpm) remains below 60 % of the target speed for longer than 100 ms. The default settings are 200 ms and 30 %.)
 - e) Set the affected end limit (SDO #2016 or #2017) so that the obstruction is clearly within the limit in each case (Otherwise there is a risk that the obstruction will lie within the positioning window and therefore not be recognised.)
 - f) If necessary, reduce the target speed for manual operation (SDO #2013)
- 2) Now start the reference run as a manual run (bit 0 or 1 in the control word).
- 3) Wait until the drive is running (bit 6 is set in the status byte)
- 4) Wait until the drive is stationary and a positioning error has occurred (bit 6 of the status byte is reset, bit 10 is set).
- 5) Using the same settings, perform a manual run in the opposite direction (move a little distance away from the obstruction so the drive can move freely).
- 6) Only now use desired settings for normal operation of the above SDOs.

4.12 Run drive in reverse

Depending on the model, the drive may be run in reverse up to a certain speed.



CAUTION!

Running a PSD4xx in reverse for more than 1-2 seconds at more than the permissible speed will damage the internal protection diode and the PSD4xx will be defective

Please refer to the following table to find the maximum permissible speed:

Device model	PSD 401/411 - 5V/8H/14H	PSD 403/413 - 8H/14H	PSD 422/432 - 8V/8H/14H	PSD 424/434 - 14H	PSD 426/436 - 14H
Max. permissible speed [rpm]	200	48	200	95	60

Device model	PSD 428/438 - 14H	PSD 480 / 490 - 5V	PSD 480/490 - 8H/14H	PSD 481/491 - 8H/14H
Max. permissible speed [rpm]	45	200	200	48

5 Technical data

Technical data and drawings can be found in the current data sheet on the website:
www.halstrup-walcher.de/technicaldocu

Please search for "PSD" and select your type, click on "Data sheets".

Please contact us if you require any further information.

6 Notes

