

# PSW 30x/32x-14

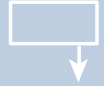

## PSW 30x/32x-14 (with hollow shaft)

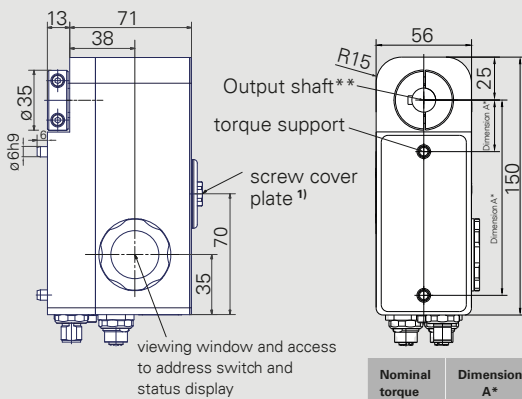

<sup>1)</sup> over a rotating manual adjustment shaft SW6/8 depth hex

## PSW 30x/32x-14 V (with solid shaft)

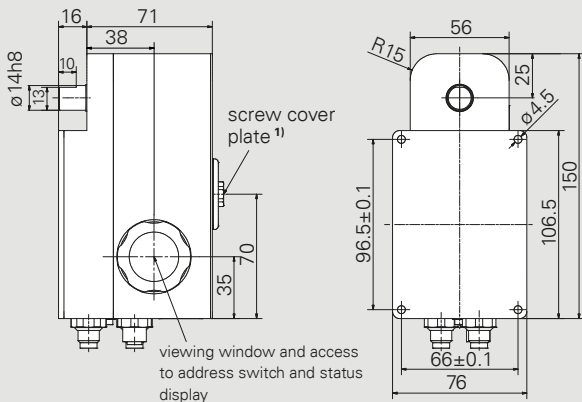

Nominal torque	Dimension A*	Output shaft**
< 10 Nm	30 ±0.1 mm	Ø14H7/20 depth
≥ 10 Nm	113.5 ±0.1 mm	Ø14H7/20 depth with feather key DIN 6885-A5x5x12

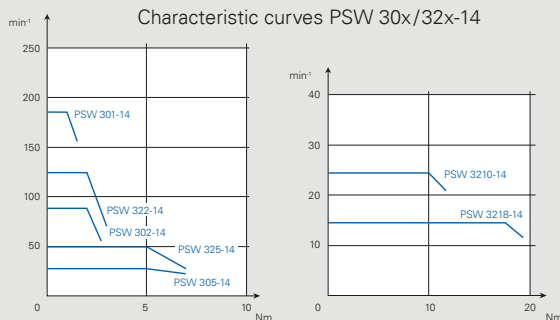

Dimensions in mm.  
For details of the connections please see also the instruction manual.

Product	Nominal torque (x)	Self-holding torque (energized)	Nominal rated speed
PSW 301-14	1 Nm	0.5 Nm	180 min <sup>-1</sup>
PSW 302-14	2 Nm	1 Nm	90 min <sup>-1</sup>
PSW 305-14	5 Nm	2.5 Nm	35 min <sup>-1</sup>
PSW 322-14	2 Nm	1 Nm	125 min <sup>-1</sup>
PSW 325-14	5 Nm	2.5 Nm	50 min <sup>-1</sup>
PSW 3210-14	10 Nm	5 Nm	25 min <sup>-1</sup>
PSW 3218-14	18 Nm	9 Nm	14 min <sup>-1</sup>

Duty cycle	20% (basis time 600s) at nominal torque
Mode of operation	S3
Supply voltage	24 VDC ±10% galvanically separated between control and motor and bus
Nominal current	PSW 30x: 2.5 A, PSW 32x: 3.2 A
Power consumption (control unit)	0.1 A
Positioning accuracy absolute measurement of position taken directly at the output shaft	0.9°
Positioning range	250 rotations <sup>3)</sup> not subject to mechanical limits
Shock resistance in accordance with IEC/DIN EN 60068-2-27	50 g 11 ms
Vibration resistance in accordance with IEC/DIN EN 60068-2-6	10..55 Hz 1.5 mm / 55..1 000 Hz 10 g / 10..2 000 Hz 5 g
Output shaft	14 mm solid shaft (not for PSW32x ≥ 10 Nm) or 14 mm hollow shaft with clamp ring (for PSW32x ≥ 10 Nm with clamp ring and feather key)
Brake	optional (holding torque=nominal torque)
Max. axial force	20 N
Max. radial force	40 N
Ambient temperature	0..45 °C
Storage temperature	-10..70 °C
Protection class	IP68 at standstill, IP66 during rotation
Material	stainless steel
Weight	2 000 g
Certificates	CE/UKCA, optional: NRTL, optional: STO with/without test pulses <sup>2)</sup>

<sup>2)</sup> STO: only for EtherCAT, EtherNet/IP, POWERLINK, PROFINET, without galvanic separation of the supply voltage

<sup>3)</sup> With PSx 3xx with IO-Link, the travel range can be increased by a multiple of the absolute measuring range of 256 revolutions and a partial absolute travel range of over 500,000 revolutions can be realized.



# How to choose your suitable positioning system?



To order our standard products, you can use the graphics on the right for an initial performance assessment of the products and the corresponding order code of the 3 series. The ordering process is described below using an example.

- A** Choose the appropriate **design** based on your operating conditions
- B** **Type:**
  - Vertical or horizontal form (value even or odd)
  - max. rated torque (x) - for orientation see characteristic diagrams
  - Output shaft (8 or 14) and solid or hollow shaft
- C** select required protocol / interface (**bus communication**)
- D** integrate the **connections** that are essential for you
- E** if necessary, select a **brake** (without brake select 0)
- F** select required **certificates**
- G** select **IP protection class**

For example, a stainless steel housing (PSW), the 30x design, a maximum rated torque of 2 Nm and an 8 hollow shaft would be required (302-8). Besides IO-Link, the standard connections are required, no brake, the CE/UKCA certificate and IP65.

→ Order code **PSW 302-8-IO-0-0-0-65**

## Torques and speeds

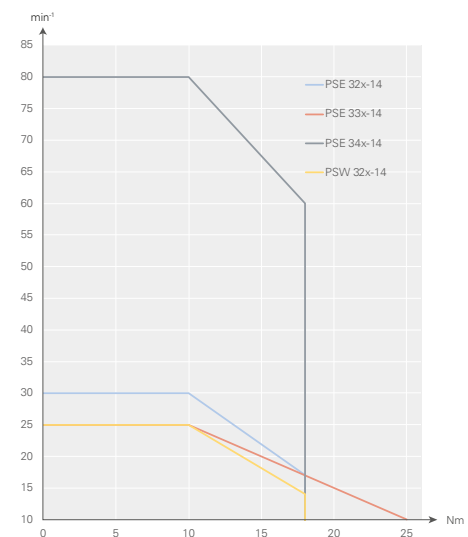
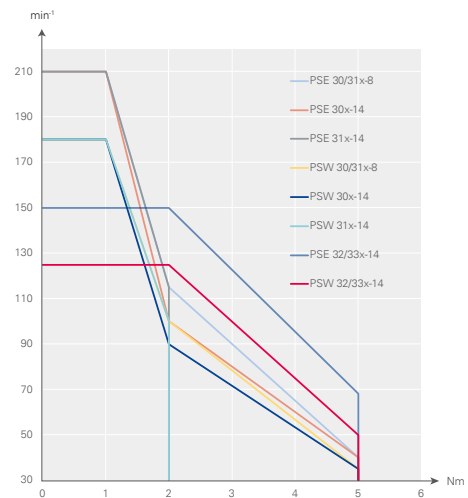



## Order code PSE / PSW 3 series



	A	B	C	D	E	F	G
	Design	Type	Bus communication	Connections	Brake	Certification	IP protection class
Positioning System <b>Efficient</b>	PSE	30x-8 30x-8 V 30x-14 30x-14 V 31x-8 31x-8 V 31x-14 31x-14 V	CA: CANopen DP: PROFIBUS DP DN: DeviceNet <sup>1)</sup> MB: Modbus RTU <sup>1)</sup> SE: Sercos EC: EtherCAT	0: Standard <sup>2)</sup> T: Standard with jog keys <sup>1)</sup> X: Plug-in, L-coded <sup>1)</sup> Y: Plug-in, Y-coded <sup>1)</sup> Z: Plug-in, Y-coded, with jog keys <sup>1)</sup>	0: without M: with <sup>3)</sup>	0: CE / UKCA N: NRTL + CE / UKCA S: STO + CE / UKCA without test pulses <sup>1)</sup> T: STO + CE / UKCA with test pulses <sup>1)</sup> Y: STO + NRTL + CE / UKCA without test pulses <sup>1)</sup> Z: STO + NRTL + CE / UKCA with test pulses <sup>1)</sup>	54: IP 54 <sup>1)</sup> 65: IP 65 <sup>1)</sup> 68: IP 68 <sup>4)</sup>
Positioning System <b>Washable</b>	PSW	32x-14 32x-14 V 33x-14 33x-14 V 34x-14 <sup>5)</sup>	PN: PROFINET EI: EtherNet/IP PL: POWERLINK IO: IO-Link				

Form/Type	Torque	Output shaft
30  horizontal	<b>x</b> = 1 Nm	8 = 8 mm hollow shaft 14 = 14 mm hollow shaft
31  vertical	<b>x</b> = 2 Nm	
32  horizontal	<b>x</b> = 5 Nm	8V = 8 mm solid shaft <sup>1)</sup> 14V = 14 mm solid shaft <sup>1)</sup>
33  vertical	<b>x</b> = 10 Nm	
34  horizontal	<b>x</b> = 18 Nm	
	<b>x</b> = 25 Nm <sup>5)</sup>	

<sup>1)</sup> Not available as standard for all versions / bus communication.

Please contact our sales department.

<sup>2)</sup> The standard is 3 plugs / sockets (except for IO-Link or Y-coded connector)

<sup>3)</sup> only for variants with 14 mm output shafts

<sup>4)</sup> only for PSW

<sup>5)</sup> only for PSE

Please refer to the data sheets for the respective standard combinations.



To place your order, please call us at

**+49 7661 3963-0** or email us at

**info@halstrup-walcher.com.**









For additional contacts, please visit

**www.halstrup-walcher.de/en/contact**



# Accessories for our positioning systems

The connectors shown here can be used for all device types (PSE / PSW). With PSE (IP 54 / IP65), this guarantees the IP protection classes. If required, we are happy to help you find a suitable connector for a PSW (IP 68) - please contact us.

Buscommunication	Power supply (+ databus connector) (for option 0) <sup>1)</sup>	Power supply + databus + jog key connector	Cable
CANopen			
PROFIBUS DP			
Modbus RTU			
DeviceNet			<p style="text-align: center;"><b>On request</b></p> 
Sercos EtherCAT PROFINET EtherNet/IP			
POWERLINK			
IO-Link			

<sup>1)</sup> see in order code under D

On request, we offer suitable adapter sleeves for adaptation to different spindle diameters.

Screw cap to cover the second bus connection (for PSE/PSW). Not suitable for PSE with IE interface.

**Order no. 9601.0176**



Jog key box  
(for Option T in section D of the Order code)

**Order no. 9601.0241**

## Software

Use our function blocks, description files or commissioning tools for the various industrial protocols. You can download the files under [www.halstrup-walcher.de/en/software](http://www.halstrup-walcher.de/en/software). To do this, enter your specific product in the drop-down menu that appears and select the Software tab in the tab view. After that, the software components are available to you.

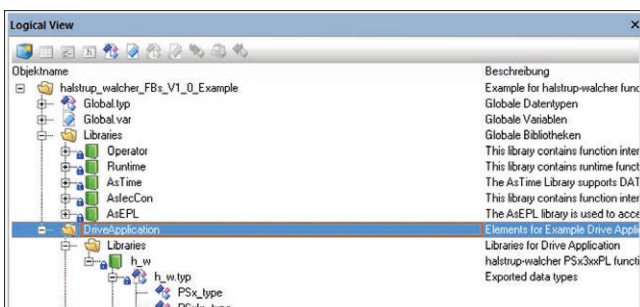

## You want to see our products in person?

We are represented at numerous trade fairs and will be happy to advise you. Visit us on site and let us find the ideal solution together. You can find our current exhibition dates and product news at:



[www.halstrup-walcher.de/en/news/](http://www.halstrup-walcher.de/en/news/)