



Instruction Manual

PSx3xxEIP-STO



halstrup-walcher GmbH

Stegener Straße 10
D-79199 Kirchzarten

Phone: +49 (0) 76 61/39 63-0

E-Mail: info@halstrup-walcher.com
Internet: www.halstrup-walcher.com

Revision Overview

Version:	Date:	Author:	Content:
A	17.02.21	La	Initial Revision
B	01.03.21	La/Me	Description of the status bits
C	28.04.21	La/Me/Ka	Translation after amendments in German version; Layout changes
D	27.07.21	Me	Parameter 23 (description); Parameter 110 (Temp-limit 80°); 4.5 (Remark No.6); 4.6 Mapping-End;
E	23.03.22	Me	Chapter 5.1 shock- and vibration resistance 4.12 manual turning; readjustment
F	08.08.23	Ts	Correction of connection timeout (p.23). New chapter Limitation of liability and cross-sections Power supply cables. Reference to axial and radial forces in chap. assembly.
G	19.06.24	Ts	Error corrections, safety topics, meaning of the operating instructions revised, intended and non-intended use added, limitation of liability revised, new product labeling, assembly chapter revised, vibration and noise emissions in Physical Data added, Plug colour designation removed

Type overview of the PSx3xxEIP-STO to which this instruction manual apply

PSE/PSS/PSW30x-x-EI-x-x-S/T/Y/Z-x
 PSE/PSS/PSW31x-x-EI-x-x-S/T/Y/Z-x
 PSE/PSS/PSW32x-x-EI-x-x-S/T/Y/Z-x
 PSE/PSS/PSW33x-x-EI-x-x-S/T/Y/Z-x

This operating manual apply to all options that can be ordered at the points marked with 'x'.

	A Design	B Type	C Bus communication	D Connections	E Brake	F Certification	G Protection class
Positioning System Efficient	PSE	30x-8 / -14 31x-8 / -14	EC: EtherCAT PN: PROFINET	0: standard T: standard with jog keys ³⁾	0: without M: with	S: STO+CE without Test pulse	54: IP 54 65: IP 65 68: IP 68
Positioning System Stainless	PSS	32x-14 33x-14	EI: EtherNet/IP PL: POWERLINK	Y: 1 connector, Y-encoded Z: 1 connector, Y-encoded, with jog keys ³⁾		T: STO+CE with Test pulses Y: STO+NRTL without Test pulse	
Positioning System Washable	PSW					Z: STO+NRTL with Test pulses	
Remarks		Other shaft diameters possible as special design Labelling 3xx-XX /So		³⁾ always via an extra connector			

Example for a device variant: PSE335-14-EI-Z-0-Z-65

PSE 335-14 - EI - Z - 0 - Z - 65
 A B C D E F G

Accessories PSx3xxEIP-STO series

We offer you the corresponding supply and data plugs for all unit types. Please contact our sales department, stating the complete type designation, at the following e-mail address Vertrieb@halstrup-walcher.de

Purpose of instruction manual

This instruction manual describes the features of the PSx3xx positioning system and provides guidelines for its use.

Every person who is tasked with carrying out work on or with the appliance must have read and understood the operating instructions before starting work on the appliance. This also applies if the person concerned has already worked with such an appliance or a similar appliance or has been trained by the manufacturer.

These appliances can pose a risk to persons and property due to improper use and incorrect operation. For this reason, every person entrusted with handling the appliances must be trained and aware of the dangers. The operating instruction and in particular the safety instruction contained therein must be carefully observed.

Always contact the manufacturer if you do not understand any parts of these instructions.

Handle these operating instructions with care:

- It must be kept within easy reach for the entire service life of the appliances.
- It must be passed on to subsequent personnel.
- Any supplements issued by the manufacturer must be included.

The manufacturer reserves the right to further develop this device type without documenting this in each individual case. Your manufacturer will be happy to provide you with information on the current status of these operating instructions.

Conformity

This device is state of the art.

It complies with the statutory requirements of the EC and UK-directives.

This is documented by the CE and the UKCA mark being affixed.



Translation of the original instructions

© 2024

The manufacturer owns the copyright to this instruction manual. It contains technical data, instructions and drawings detailing the devices' features and how to use them. It must not be copied either wholly or in part or made available to third parties.

These operating instruction is part of the product. Read these instructions carefully, follow our instructions and pay particular attention to safety instructions. The instructions should be available at all times.

Table of Contents

Revision Overview	2
Accessories PSx3xxEIP-STO series	3
Purpose of instruction manual	3
Conformity	3
Table of Contents	5
1. Safety precautions	7
1.1. Qualified personnel.....	7
1.2. Explanation of symbols	7
1.3. Appropriate use	8
1.4. Inappropriate use.....	9
1.5. Limitation of liability.....	10
1.6. Faults, maintenance, repair, disposal.....	10
1.7. Product labeling	11
2. Device description	12
2.1. Features	12
2.2. Safe Torque Off	12
3. Installation	13
3.1. Electrical connection.....	13
3.2. Assembly of the positioning system	14
3.2.1. Hollow shaft	14
3.2.2. Solid shaft.....	16
3.3. Disassembly	16
3.4. Powering the device	17
3.5. Pin assignment.....	17
3.5.1. Supply voltage and STO connector (24VDC/STO).....	18
3.5.2. Round socket for bus (Port 1 and Port 2).....	18
3.5.3. One Hybrid bushing for supply, bus and STO (Hybr)	18
3.5.4. Connector for jog keys (Jog).....	19
3.5.5. Electrical grounding (Chassis)	19
3.6. Setting of the IP address.....	20
3.7. LEDs.....	21
3.8. Start-up.....	22
3.8.1. Positioning run.....	22
3.8.2. Manual run	23
3.9. EtherNet/IP interface	24
3.9.1. Table of implemented parameter entries (class 0x64; instance 1).....	26
3.9.2. Table of rated speed and torque values for various models of gears	33
3.9.3. Process data format.....	36
3.9.4. Detailed description of the status bits.....	37
3.9.5. Detailed description of control bits	40
3.9.6. Parameter interface	42
4. Sequence of positioning	45
4.1. Positioning sequence with loop.....	45
4.2. Positioning sequence without loop.....	46
5. Specials	47
5.1. Speed, acceleration and deceleration	47
5.2. Maximum starting torque and maximum torque	47
5.3. Response of drive in case of block	47
5.4. Behaviour of the actuator during manual rotation (readjustment function).....	48
5.5. Calculating the absolute physical position.....	49
5.6. Use of the "Upper mapping end" parameter.....	51

5.6.1. Delivery state	51
5.6.2. Shifting the positioning range upwards starting from the delivery state	52
5.6.3. Shifting the positioning range downwards starting from the delivery state	53
5.6.4. Shifting the positioning range depending on the actual position	54
5.6.5. Step-by-step instructions for determining the positioning range	55
5.7. Using position scaling factors to set the spindle pitch	56
5.8. Drag error monitoring	57
5.9. Drag error correction	57
5.10. Abort run when the master fails	57
5.11. Devices with "Jog keys" option	58
5.12. Manual turning with the adjustment facility	59
5.13. Devices with optional snap brake	59
5.14. Reference runs	60
5.15. Reverse drive	61
5.16. Safe Torque Off	62
6. Technical Data	63
6.1. Ambient conditions	63
6.2. Electrical data	64
6.3. STO Data	64
6.4. Physical data	65
7. Certificate of Conformity	66

1. Safety precautions

This section provides an overview of all the important safety aspects for optimum protection of personnel and for safe and trouble-free operation.

1.1. Qualified personnel

These operating instructions are intended for qualified electricians and fitters who are authorized to install, electrically connect, commission and label devices and systems in accordance with safety standards, as well as for the operator and manufacturer of the system on which the drives are installed.

The personnel must be provided with all applicable accident prevention and safety regulations that arise during commissioning or installation of the system. It must be ensured that the personnel are familiar with all applicable accident prevention and safety regulations.

1.2. Explanation of symbols

In these operating instructions, the following highlights are used to draw attention to the hazards described below when handling the system:

⚠ DANGER	DANGER! Indicates a situation of imminent danger, which will lead to a fatality or serious injuries if not prevented.
⚠ WARNING	WARNING! Indicates a potentially dangerous situation, which may lead to a fatality or serious injuries if not prevented.
⚠ CAUTION	CAUTION! Indicates a potentially dangerous situation, which may lead to minor/slight injuries if not prevented.
NOTICE	NOTICE Indicates a potentially harmful situation, which may lead to material damage if not prevented.

1.3. Appropriate use

Positioning systems are especially suitable for automatically setting tools, stops or spindles for wood-processing equipment, packing lines, printing equipment, filling units and other types of special machines.

PSx3xx positioning systems are not stand-alone devices and may only be used if coupled to another machine.



WARNING

Personal injury and property damage due to incorrect use of the products!

The positioning systems are designed for use in an industrial environment and may only be used as intended. If they are not used as intended, situations may arise that result in damage to property and personal injury.

NOTICE

The device is used as intended if all instructions and information in these operating instructions are observed.

- Only operate the device in perfect technical condition
- When attaching to a machine, observe the current safety regulations.
- Do not operate the product in all installed state unless all necessary protective measures have been taken.
- Observe the relevant regulations for the prevention of accidents (e.g. accident prevention regulations).
- In order to avoid the risk of accidents due to contact with moving parts, appropriate separating or non-separating guards must be provided.
- Use appropriate protective equipment (e.g. safety helmet, safety goggles, safety shoes, protective gloves).
- Use appropriate assembly and transport equipment.
- Store and transport the product in its original packaging, reuse protective caps for plugs if necessary.
- Adequate ventilation must be provided at the point of use to avoid excessive heating.
- During project planning, ensure that the device is always operated within its specifications. See technical data in chapter 6. Technical Data.
- If the device is equipped with a brake, it is not a safety brake that may be used for safety functions.
- In special areas of application such as the chemical, pharmaceutical or food sector, the positioning system in stainless steel design is possible.

1.4. Inappropriate use

The use of the positioning devices outside of the operating conditions and technical data and specifications described in the documentation is considered “improper”.

The drives are designed for intended operation under normal ambient conditions (according to EN / IEC / UL 61010-1), with the exception of an extended temperature range.

- Operation inside buildings
- Operation at altitudes up to 2000m above sea level
- Ambient temperatures deviating from standard: 0°C to 45°C
- Maximum relative humidity 80% at temperatures up to 31°C, decreasing linearly to 50% relative humidity at 45°C
- Fluctuations in the supply voltage up to $\pm 10\%$ of the nominal voltage at 50% relative humidity at 45°C
- The IP-protection rating is a manufacturer specification.

Any use of the device that goes beyond the intended use and/or is used differently can lead to dangerous situations

- Underwater usage of the PSW is not allowed
- The positioning system cannot be used for certain applications, such as the transport of people and animals or as a press-bending device for cold processing of metal.
- If the operation requirements stated in chapter 6. Technical Data are exceeded, personal injury or property damage may occur.
- The positioning system cannot be used in hazardous areas.
- The holding brake must not be used to brake the motor.
- Under no circumstances may the housing cover be used for power transmission purposes, e.g. for supporting, climbing or similar.

1.5. Limitation of liability

The device may only be operated in accordance with these operating instructions. All information and instructions in these operating instructions have been compiled taking into account the applicable standards and regulations, the state of the art and our many years of experience and knowledge.

The manufacturer accepts no liability arising from improper or unintended use. Warranty claims also expire in this case:

- non-observance of the operating instructions
- improper use
- improper installation
- improper use
- Use by untrained personnel
- Modifications to the device
- Technical modifications
- Unauthorized modifications

The user is responsible for carrying out commissioning in accordance with the safety regulations of the applicable standards and all other relevant national or local regulations regarding conductor dimensioning and protection, grounding, circuit breakers, overcurrent protection, etc. The person who carried out the assembly or installation is liable for any damage caused during assembly or connection.

1.6. Faults, maintenance, repair, disposal

Faults or damage to the appliance must be reported immediately to the specialist personnel responsible for the electrical connection.









The appliance must be taken out of operation by the responsible specialist personnel until the fault has been rectified and secured against accidental use.

The appliance requires no maintenance.

Repair work that requires the housing to be opened may only be carried out by the manufacturer.

The electronic components of the appliance contain environmentally harmful substances and are also recyclable materials. The device must therefore be recycled after its final decommissioning. The environmental guidelines of the respective country must be observed.

1.7. Product labeling

Warning symbol	Meaning
	Reference to further documentation Read the operating instructions and safety instructions before transportation, installation or commissioning
	Warning of hot surface The appliance can become very hot during operation. Temperatures of over 70°C can occur. In the event of a fault, internal components may be overloaded. Use personal protective equipment or wait long enough for the appliance to cool down.
	Warning of dangerous electrical voltage Before working on the product, check that all power connections are de-energized!
	Disposal of batteries, electrical and electronic equipment <ul style="list-style-type: none"> • In accordance with international regulations, batteries, rechargeable batteries and electrical and electronic equipment must not be disposed of with household waste. • The owner is legally obliged to dispose of these devices properly at the end of their service life. • WEEE: This symbol on the product, its packaging or in this document indicates that a product is subject to these regulations.
	CE marking CE stands for "Conformité Européenne". The CE marking expresses the conformity of a product with the relevant EC directives.
	UKCA marking UKCA stands for "UK Conformity Assessed". The UKCA marking expresses the conformity of a product with all applicable legal requirements of the United Kingdom.
	Safe torque off Corresponds to stop category 0 in accordance with EN 60204-1. The power supply to the drive is interrupted immediately and the drive is brought to an uncontrolled standstill
	GROUNDING Chassis grounding (description in chapter 3.7.5 Electrical grounding (Chassis))

2. Device description

2.1. Features

The PSx3xx positioning system, an intelligent, compact, complete solution for positioning auxiliary and positioning axes, consists of an EC motor, gear power amplifier, control electronics, absolute measuring system and EtherNet/IP interface. The integrated absolute measuring system eliminates the need for a time-consuming reference run. Connecting to a bus system simplifies the wiring. A hollow shaft with adjustable collar makes assembly quite simple. The positioning system is especially suitable for automatically setting tools, stops or spindles for wood-processing equipment, packing lines, printing equipment, filling units and other types of special machines.

PSx3xx positioning systems convert a digital positioning signal into an angle of rotation.

2.2. Safe Torque Off

This device variant (STO) contains functions of the functional safety “Safe Torque Off”



CAUTION

The specific information about the safety function can be found in the safety manual (Document No. 7100.006654).

When using the STO function, the conditions and instructions given in the safety manual must be observed in order to achieve the required level of safety.

This operation manual contains only basic information about the STO functionality.

3. Installation

3.1. Electrical connection

NOTICE

The following notes on the power supply should be observed.

Minimum cross-sections are required for connection to the power supply. For power cables mounted on the device, use only the cross-sections listed below. In order to minimize voltage drop on longer cables, we always recommend using the largest available cross-section.

Device	Cable cross-section
PSEx31 / PSx32 / PSx33	min. AWG20 or 0,5 mm ²
PSEx34	min. AWG18 or 1,0 mm ²
Fieldbus connections	min. AWG23 or 0,25 mm ²

If there are concerns about mechanical strength or where cables may be exposed to mechanical damage/stress, they must be protected accordingly. This can be ensured, for example, by a cable duct or a suitable armoured pipe.

If the power supply cables are laid in the immediate vicinity of the drives or other heat sources, make sure that the cables have a temperature resistance of at least 90°C. With suitable design measures, e.g. sufficient ventilation or cooling, lower temperatures are also permissible. This must be checked and determined by the customer.

Make sure that the flammability class of the cable for the USA is equivalent to UL 2556 VW-1, e.g. according to IEC 60332-1-2 or IEC 60332-2-2 depending on the cross-section. For Canada, the flammability class FT1 is required, FT4 exceeds this and is therefore also permissible. Cables for the North American market often meet both requirements.

However, the flammability class requirements only apply if you do not limit to Class 2 (e.g. certified power supply) or to <150 W according to UL 61010-1
→ 3.6 Powering the device by means of a suitable fuse.

When installing in North America, please observe the specifications in the National Electrical Code NFPA 70 and the Electrical Standard for Industrial Machinery NFPA 79 (USA) or the Canadian Electrical Code and C22.2 (Canada) in the respective valid version.

Note the limitations of liability → 1.5 Limitation of liability.

3.2. Assembly of the positioning system

CAUTION

The maximum permissible axial and radial forces (see chapter 6.4 Physical data) on the motor shaft must not be exceeded during transportation, installation or operation.

CAUTION

Take the weight of the device into account when selecting the fastening screws! Tightening torques of the fixing screws according to the screw manufacturer's specifications!

WARNING

Rotating and/or linearly moving components can cause serious injuries. If there is a risk of accidents during installation or operation, the moving parts must be fitted with guards or protective devices.

NOTICE

Temperature overload

The PSx3xx positioning unit has a simple temperature measuring device to prevent thermal overload. If the temperature in the device exceeds the limit temperature set in the parameterization, this bit is set and repositioning is only possible after the device has cooled down ('Temperature exceeded' bit reset).

3.2.1. Hollow shaft

The PSx3xx is mounted on the machine by sliding it with the hollow shaft onto the spindle to be driven and fixing it with the clamping ring (recommended shaft diameter 8 h9 or 14 h9; tightening torque of the clamping ring screw with 3 mm hexagon socket: 1.5 Nm).

CAUTION

The depth of the hollow bore is 20 mm. For optimum operation, the pin of the shaft to be driven should correspond to this depth. Depending on the operating situation, significantly shorter pins (< 16 mm) may cause damage to the PSx3xx. When mounting the PSx3xx, it should only be pushed on until the foam rubber plate lies evenly on the bottom of the machine or is compressed to approx. half its thickness. Under no circumstances may the PSx3xx "hard" be screwed to the machine without an air gap.

The rotation lock is made via the pin (in the picture below the hollow shaft) into a suitable bore as rotary torque support. This hole must be slightly larger than the diameter 6 h9 of the pin. An oblong hole or slot with a slightly larger width (recommended: 6.05...6.10 mm) than the dimension of the pin diameter is optimal. The backlash when changing the direction of rotation has a direct influence on the positioning accuracy and can lead to damage to the PSx3xx with very large backlash (a few mm) due to the impact load

CAUTION

The PSx3xx must have a little gap on all sides when mounted, as it can move axially and/or radially during positioning if the hollow shaft and solid shaft are not 100% aligned. This "staggering" is not a defect of the PSx3xx and also has no influence on the function, as long as it can move freely. Please note the maximum permissible radial force and axial force in chapter → 6.4 Physical data.

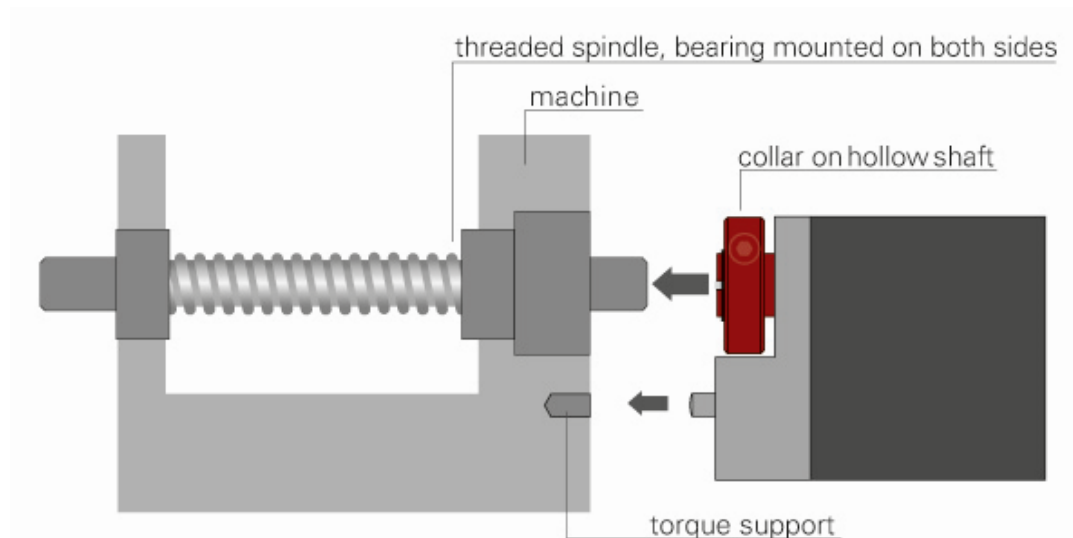

Versions with higher torques (from 10 Nm):

Here the force connection is made via a feather key DIN 6885-A5x5x12.

The clamping ring is not freely rotatable but consists of two halves, the fixed part of the hollow shaft and the loose clamping clamp. The keyway is located in the half that is fixed to the output shaft. When sliding onto the shaft to be driven with the key inserted, its angular position must be aligned with the keyway in the PSx3xx. After pushing on, the PSx3xx is fixed with the 2 screws in the flexible clamping ring half. Make sure that both screws are tightened as equally as possible (tightening torque of the screws with 3 mm hexagon socket: 1.5 Nm).

The information on torque support applies in the same way as described above.

For PSE30x-14, PSE32x-14, PSS30x-14 and PSS32x-14, the position of the ant rotation lock can be set at greater distances by unscrewing the base cover, turning it 180° and then screwing it back on. When screwing on, make sure that the seal is correctly inserted in the floor.

For torques > 5 Nm we recommend to choose the greater distance.

3.2.2. Solid shaft

The PSx3xx is installed on the machine by mounting the drive to the axis to be driven using a coupling and an intermediate flange.

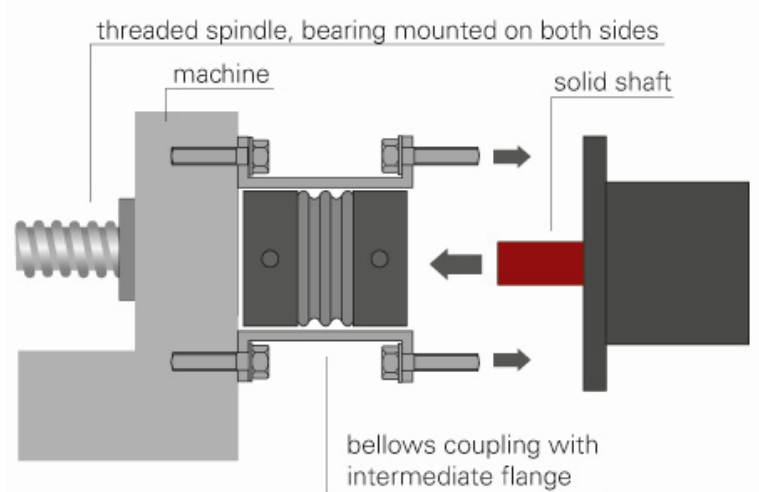

CAUTION

Under no circumstances may the housing cover be used for the purpose of the transmission of force.

CAUTION

Never apply force to the housing cover, e.g., for supporting weight.

CAUTION

Driving the PSx3xx rearward is prohibited (e.g. it's not allowed to turn the output shaft by an external force).

3.3. Disassembly



To remove the PSx3xx from the shaft, release the clamp (for versions with hollow shaft the clamping ring) and pull the PSx3xx off the shaft. If possible, the PSx3xx should only be pulled axially. Excessive bending back and forth can damage the output shaft!

For versions with brake, it is essential to observe the instructions in chapter 4.13

3.4. Powering the device

 CAUTION
<p>There is one common power supply for the motor and control unit of the positioning system.</p> <p>It is recommended, to use SELV or PELV power supplies.</p> <p>For the combined motor and control power, use a single fuse with max. 3.5 A for each PSx3xx</p> <p>It is strongly recommended to separate power cables to the PSx3xx from other power cables that might have dangerous voltage.</p>

 CAUTION
<p>Underwater usage of the PSW is not allowed.</p>

 CAUTION
 Please consider that the device might have a hot surface during operation!

3.5. Pin assignment

 CAUTION
<p>Please take care that the mating connectors and the used cables match the connectors in the PSx3xx and are mounted correctly, in order to achieve the protection class.</p>

3.5.1. Supply voltage and STO connector (24VDC/STO)

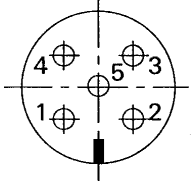
connector pattern (external top view)	assignment	type
	<ol style="list-style-type: none"> 1. +24V motor / control 2. GND motor / control 3. STO input 4. N.C. 5. housing/pressure balance 	PSE/PSS: M12 (A-cod.); 5-pol. PSW:M12 (A-cod.); 4-pol. with airtube

NOTICE

To prevent the ingress of fluids into the PSW-housing during cooldown, use a special cable with an airtube for pressure balancing of your PSW.

NOTICE

In the special version with two M12 supply plugs, a maximum of 3 drives may be connected in series. Due to the maximum current load of the connectors, the drives must not be positioned synchronously.

3.5.2. Round socket for bus (Port 1 and Port 2)

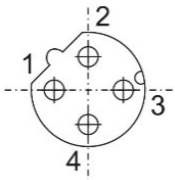
connector pattern (external top view)	assignment	type
	<ol style="list-style-type: none"> 1. TD+ 2. RD+ 3. TD- 4. RD- 	M12 (D-cod.); 4-pol.

NOTICE

Due to the use of 5-pin sockets, only five-wire cables should be used.

3.5.3. One Hybrid bushing for supply, bus and STO (Hybr)

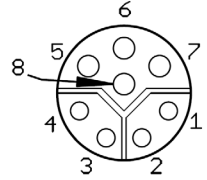
connector pattern (external top view)	assignment		type
	<ol style="list-style-type: none"> 1. TD+ 2. TD- 3. RD+ 4. RD- 	<ol style="list-style-type: none"> 5. GND motor / control 6. N.C. 7. +24V motor / control 8. STO input 	M12 (Y-cod.); 8-pol.

3.5.4. Connector for jog keys (Jog)

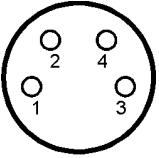
connector pattern (external top view)	assignment	type
 <p>The diagram shows a circular connector with four pins arranged in a square pattern. The pins are numbered: 1 at the bottom-left, 2 at the top-left, 3 at the bottom-right, and 4 at the top-right.</p>	<ol style="list-style-type: none"> 1. +24V (output) 2. forward key 3. reverse key 4. GND 	<p>M8; 4-pol.</p>

3.5.5. Electrical grounding (Chassis)

Next to the connecting plugs there is a M4 stud bolt. It is recommended to connect the positioning system with a cable as short as possible to the machine base. The minimum conductor cross-section for this is 1.5 mm².

3.6. Setting of the IP address

The IP address might be provided by 5 different ways:

- 1) Address assignment via DHCP:
For this purpose set address **99** with the help of the address switches (if present) before power up the device.
- 2) Address assignment via BOOTP:
For this purpose set address **98** with the help of the address switches (if present) before power up the device.
- 3) Use the last assigned and saved address:
For this purpose set address **97** with the help of the address switches (if present) before power up the device. Then IP address, netmask and gateway comes out of the internal EEPROM and will be used if they are $\neq 0$.
- 4) Assign a fixed address with the help of address switches:
For this purpose set an address in the area **1...96** with the help of the address switches (if present) before power up the device. The following settings will result:
 - IP address = 192.168.1.0 + value of address switches
 - netmask = 255.255.255.0
 - gateway = 0.0.0.0 (not used)
- 5) Use the last address assigning method which has been set by the EIP scanner:
For this purpose set address **0** with the help of the address switches (if present) before power up the device.

TCP/IP-Object; attribute 3 (configuration control) was at last

- 0 → IP address, netmask and gateway comes out of the internal EEPROM and will be used if they are $\neq 0$.
- 1 → Address assignment via BOOTP
- 2 → Address assignment via DHCP

The value of attribute 3 will be stored with each change in the EEPROM and is being evaluated after the next power-up.

NOTICE

By setting "configuration control" to 0 the IP address which is used actually (e.g. received by DHCP) can be saved permanently in the EEPROM of the drive.

NOTICE

Concerning variants with address switches, the IP address which is used actually (e.g. received by DHCP) can be saved permanently in the EEPROM of the drive by setting the address switch from a value $\neq 97$ to 97 when the drive is powered up.

In the delivery state the address switches (if present) are in switch setting 0, the default setting of "configuration control" is 2.

I.e. in the delivery state the address assignment is always carried out via DHCP.

3.7. LEDs

The following LEDs are located under the transparent sealing plug:

P1/P2: green LINK LEDs and yellow ACT LEDs for ports 1 and 2

MS: EtherNet/IP Module Status LED

NS: EtherNet/IP Network Status LED

V_Motor: The LED is illuminated yellow when power is available to the motor.

Switch and LED configurations:

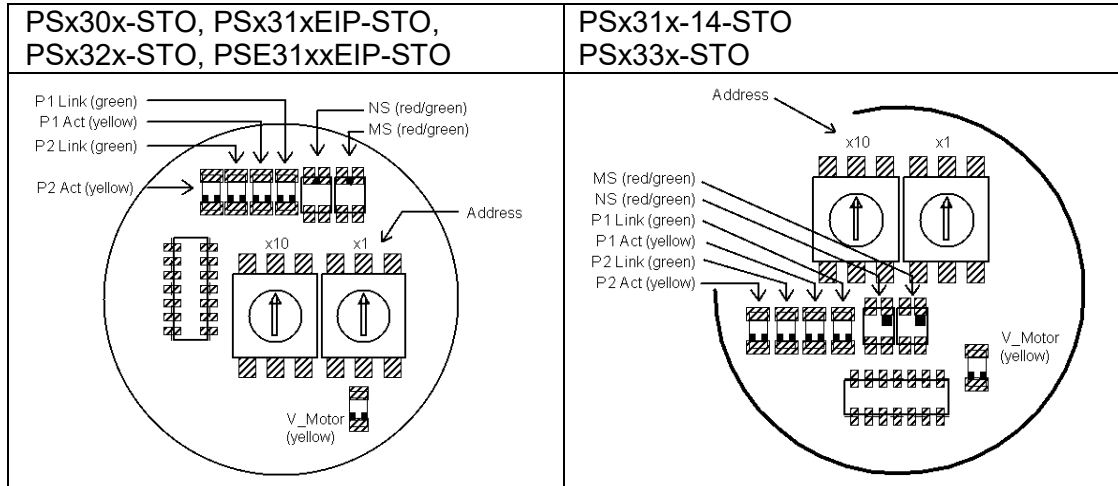

NOTICE

If the device names are given **without** the diameter of the output shaft (-8, -14), the relevant information is valid for **all** offered output shafts (applies throughout the document).

'x' in the device name stands for a number in the range 0..9. 'xx' in the device name stands for a number in the range 10..999.

NOTICE

Always replace the protective cap after setting the address. This will prevent dust and contaminants from entering the device.

Meaning of the LEDs:

1) Each of the ports (P1/P2) has two associated LEDs (one green for the "Link" state and one yellow for the "Activity" state).

For each port the following states are possible:

- green off, yellow off → no line connection
- green on, yellow off → line connection is active, no data activity
- green on, yellow is flickering with 10 Hz → line connection is active, data activity

2) red/green LED "Module Status" (MS)

- off → No power is supplied to the device.
- flashes red/green → Self test (only after power up resp. a reset command)
- flashes red → Minor recoverable fault (e.g. incorrect configuration)
- red on → Major internal fault
- flashes green → Standby (not configured → e.g. no valid IP address)
- green on → operates correctly (e.g. got a valid IP address)

3) red/green LED "Network Status" (NS)

- off → no power or no IP address has been assigned
- flashes red/green → Self test (only after power up resp. a reset command)
- flashes red → Timeout of one or more connections
- red on → duplicate IP address
- flashes green → no EtherNet/IP connection to the scanner is established
- green on → at least one EtherNet/IP connection to the scanner is established

4) The yellow "motor" LED indicates the motor power supply:

- off → Motor power supply too low or too high
- on → Motor power supply well
- flashing (~0,5 Hz) → Motor power supply well, PSx in delivery state

3.8. Start-up

After the supply voltage has been hooked up, a positioning or manual run can begin immediately:

NOTICE

For the start-up of the STO safety function see separate safety manual (Document No. 7100.006654).

3.8.1. Positioning run

To be able to control the drive with the help of process data, first a cyclic process data connection has to be established, alternatively each command may be transferred with explicit messages via UCMM.

In order to command a positioning run, the following commands are relevant:

- Transfer target value:
 - control word = 0x14 and desired target value (both in process data)
 - OR
 - control word = 0x10 in Par. 3 and target value in Par. 4 (both as "expl. request")
 - Drive begins to run
- Abort run by resetting the release bit:
 - control word = 0x00 (in process data)
 - OR
 - control word = 0x00 in Par. 3 (as "expl. request")
- If a new target value is transferred during a positioning run, the device will immediately proceed to the new target. There will be no interruption if the direction of rotation does not need to be altered.

- If a manual run is transmitted during a positioning run, the positioning run will be aborted (speed will be reduced to that of a manual run) and the device proceeds with the manual run.

The following sequence of steps is also possible:

Starting situation: release has not been set

- Transfer target value:
 - control word = 0x04 and desired target value (both in process data)
 - OR
 - control word = 0x00 in Par. 3 and target value in Par. 4 (both as "expl. request")
 - Set release:
 - control word = 0x10 (in process data)
 - OR
 - control word = 0x10 in Par. 3 (as "expl. request")
- Drive begins run

NOTICE

Where applicable, positioning runs involve a "loop run" which causes the target position to be reached from a predefined direction. The direction and the length of the loop run can be set to the desired value with Par. 42 ("length of loop") before the run. With Par. 42 the loop run might also be disabled.

NOTICE

The transmission of control word and target value with the help of explicit requests is only possible if NO cyclic process data connection is active.

3.8.2. Manual run

In order to command a positioning run, the following commands are relevant:

- Start manual run (control word = 0x11 resp. 0x12; in process data or as expl. request in Par. 3): Drive begins run
- End manual run by clearing the manual run command (transmit control word = 0x10) or by deasserting the release (transmit control word = 0x00).
- Transferring a target value during a manual run will end the manual run and the device will immediately move on to the transmitted position:
 - control word = 0x14 and desired target value (both in process data)
 - OR
 - target value in Par. 4 (as "expl. request"), the drive then automatically deasserts the manual run bits in the control word (bits 0 and 1)

3.9. EtherNet/IP interface

Pure UCMM based as well as connection based communication with assemblies is supported for the process data (see the EDS file which belongs to the device).

To move the drive, the control word as well as the target position have to be set appropriate. These are encapsulated in the Assem100 together with the output data of the parameter interface (PLC output data).

The feedback of the drive (PLC input data, Assem101) consists of a state ("status word") and the actual values of speed and position ("actual speed", "actual position") as well as the input data of the parameter interface.

The parameters (e.g. target speed) can be set on three different ways:

- 1) Via the configuration during the connection establishment (Assem104)
- 2) Acyclic with read/write requests
- 3) Via the parameter interface in the process data (Assem100, Assem101)

The parameter values are stored non-volatile in the drive. That is to say, if particular (or all) values are not being configured, the drive works with the saved value. In the delivery state these are the default values which are suitable for many applications.

Configuration:

Just before the effective value, which a parameter shall receive, a control bit has to be transmitted, which specifies if the drive shall take over or ignore the configuration value. If the configuration value shall be ignored, this control bit has to be set to 0, otherwise it will be taken over.

Example: In order to take over the target speed in the configuration, the control bit "target speed - Enable" has to be set to 1, the value in "target speed - Value" then will be taken over as target speed. The advantage of this method is when doing a parametrization in the context of running up a device, a parameter might be taken over out of the project design or alternatively the values which are stored in the EEPROM of the drive keep their validity. The control bit, which was described before, and which is present for each parameter in the EDS file and which is being displayed in the project design, is controlling this.

Content of the configuration are the parameter numbers 26 to 110. The corresponding control bits are located in the parameter numbers 25 to 109.

Process data:

As process data for the EIP scanner a 16 byte output assembly and a 16 byte input assembly exist. With the help of process data positioning runs can be activated and monitored. Besides, parameters might be written and read, for this the feature "parameter interface" is being included.

Acyclic read and write requests:

Access on all parameters is also possible with acyclic read and write requests instead via the parameter interface. The parameter number is in both cases the same.

When using acyclic write requests, it has to be considered that just before the effective value which a parameter shall receive, a control byte has to be transmitted, which specifies if the drive shall execute or ignore the write request. If the write request shall be ignored, this control byte has to be set to 0, otherwise the write request will be executed.

NOTICE

Thus, the data length of the write requests result to 3 byte for 16-bit values and 5 byte for 32-bit values.

NOTICE

For acyclic reading, the data length of the returned value is 2 byte for 16-bit values and 4 byte for 32-bit values.

The advantage of this method is when doing a parametrization in the context of running up a device, a parameter might be taken over out of the project design or alternatively the values, which are stored in the EEPROM of the drive, keep their validity. This is being controlled by the control byte, which was described before, and which is present for each parameter in the GSD file and which is being displayed in the project design.

3.9.1. Table of implemented parameter entries (class 0x64; instance 1)

Name	Par. Number	Function	Type/Range	Back up	Delivery State	R/W
Status requests						
status word	8	<p><u>Bit 0</u>: target position reached</p> <p><u>Bit 1</u>: drag error</p> <p><u>Bit 2</u>: reverse jog key active</p> <p><u>Bit 3</u>: forward jog key active</p> <p><u>Bit 4</u>: STO-enabling active</p> <p><u>Bit 5</u>: positioning run aborted</p> <p><u>Bit 6</u>: drive is running</p> <p><u>Bit 7</u>: temperature exceeded</p> <p><u>Bit 8</u>: movement opposite loop direction</p> <p><u>Bit 9</u>: measuring system or STO hardware error</p> <p><u>Bit 10</u>: positioning error (block)</p> <p><u>Bit 11</u>: manual displacement</p> <p><u>Bit 12</u>: Incorrect target value</p> <p><u>Bit 13</u>: failure voltage control</p> <p><u>Bit 14</u>: positive range limit</p> <p><u>Bit 15</u>: negative range limit</p>	0 ... 0xFFFF 16 bit			R
actual speed	9	value in 1/min	±15 bit			R
actual value	10	<p>current actual position</p> <p>value in 1/100 mm (for a 4mm spindle and default settings of numerator, Par. 28 and denominator, Par. 30)</p> <p>Writing onto this parameter causes the current position to be “referenced” onto the transferred value.</p> <p>Changes only possible when at standstill</p>	±31 bit	no		R/W
actual torque	14	value in cNm	16 bit			R
maximum torque	15	<p>maximum torque occurring during the most recent run (start phase, during which the maximum start-up torque applies, see Par. 66/76, and the phase when the drive is breaking down, are not considered)</p> <p>value in cNm</p>	16 bit			R
U control	16	current supply voltage for control unit given in increments of 0.1 V	16 bit			R
U motor	17	current supply voltage for motor given in increments of 0.1 V	16 bit			R
device temperature	18	internal device temperature in °C	16 bit			R
address switch	19	current setting of the (optionally present) address switch	16 bit			R
production date	20	year and week of manufacturing (given as an integer)	YYWW 16 bit			R
serial number	21	serial device number	0 ... 65535 16 bit			R

Name	Par. Number	Function	Type/Range	Back up	Delivery State	R/W
Status requests (continued)						
device model (as number)	22	device model within the PSE series as number (e.g. 31208)	16 bit			R
device model (as string)	23	device model within the PSE series as string (e.g. "PSE312-8-B") When requesting with "Get Attribute Single", the drive is sending the string "PSE3", when requesting via the parameter interface, consecutively 5 segments have to be requested (IND = 0...4), with each of them containing 4 byte (example for the first read double word: 0x50534533). The string is zero-terminated.				R
version	24	software version number	16 bit			R
Run commands						
control word (via explicit request only writable, if no cyclic process data connection is active)	3	<p>Bit 0: manual run to larger values</p> <p>Bit 1: manual run to smaller values</p> <p>Bit 2: transfer target value</p> <p>Bit 3: Enable manual operation in jog mode. If the bit is cleared, only single steps are possible in jog mode</p> <p>Bit 4: release: The axle will only run if this bit is set.</p> <p>Bit 5: Enable jog mode with keys: When the bus connection is active, the external keys are only active when the bit is set.</p> <p>Bit 6: Run without loop</p> <p>Bit 7: Execute switch-on loop movement</p> <p>Bit 8: Jog to larger values</p> <p>Bit 9: Jog to smaller value</p> <p>Bit 14: acknowledgment</p> <p>All other bits must be set to 0!</p>	16 bit	no	0	R/W
target value (via explicit request only writable, if no cyclic process data connection is active)	4	target position to be achieved value in 1/100 mm (for a 4mm spindle and default settings of numerator, Par. 28 and denominator, Par. 30)	±31 bit	no	0	R/W

Parameter group "position settings"						
direction of rotation	26	0: clockwise with larger values (if looking at the output shaft) 1: counter clockwise with larger values Changes only possible when at standstill	0 or 1 16 bit	yes	0	R/W
position scaling, numerator	28	These values can be used to set a desired user resolution to the drive. For a numerator factor of 400, the denominator factor holds the spindle pitch per resolution	1...10000 16 bit	yes	400	R/W
position scaling, denominator	30	e.g.: spindle pitch 1.5 mm with resolution 1/100 mm: numerator = 400, denominator = 150 Changes only possible when at standstill	1...10000 16 bit	yes	400	R/W
referencing value	32	correction factor for the target, actual and limit switch values Changes only possible when at standstill	±31 bit	yes	0	R/W
upper mapping end	34	definition of the positioning range relative to the absolute measuring system permissible values: (actual position value + 3 revolutions) ... (actual position value + 253 revolutions) Changes only possible when at standstill	±31 bit	yes	102400	R/W
upper limit	36	maximum permitted target position minimum value: upper mapping end - 253 revolutions maximum value: upper mapping end - 3 revolutions Changes only possible when at standstill	±31 bit	yes	101200	R/W
lower limit	38	minimum permitted target position minimum value: upper mapping end - 253 revolutions maximum value: upper mapping end - 3 revolutions Changes only possible when at standstill	±31 bit	yes	1200	R/W
positioning window	40	permissible difference between target and actual values for "position reached" bit value in 1/100 mm (for a 4mm spindle and default settings of numerator and denominator) The maximum value that can be set changes according to the same factor as the resolution. Changes only possible when at standstill	1...100 16 bit	yes	2	R/W
length of loop	42	minimum number of increments which the drive moves in a pre-defined direction when approaching a target position value in increments (value = 0 → no loop) Changes only possible when at standstill	-1...1 rotation ±31 bit	yes	-250	R/W

Name	Par. Number	Function	Type/Range	Back up	Delivery State	R/W
Parameter group "position settings" (continued)						
drag error	44	maximum drag error before the "drag error" bit is set. value in 1/100 mm (for a 4mm spindle and default settings of numerator and denominator)	0...1000 16 bit	yes	0	R/W
readjustment	46	readjustment at standstill 0 → off; 1 → on	0 or 1 16 bit	yes	0	R/W
drag error correction	48	maximum modification of the target speed for drag error correction Changes only possible when at standstill	0...10 16 bit	yes	4	R/W
size of individual increment	50	number of increments when external keys pressed (or when activating a jog run bit) for a short-time The maximum value that can be set changes according to the same factor as the resolution. Writing is only possible at standstill.	1...100 16 bit	yes	1	R/W
Parameter group "velocity"						
target speed	52	maximum rpm to be used for positioning runs; value in 1/min	*) 16 bit	yes	*)	R/W
target speed for manual run	58	maximum rpm to be used for manual runs value in 1/min	*) 16 bit	yes	*)	R/W
speed limit for aborting run	60	value in % of the target speed	30...90 16 bit	yes	30	R/W
acceleration	62	value in 1/min per sec.	*) 16 bit	yes	*)	R/W
deceleration	64	value in 1/min per sec.	*) 16 bit	yes	*)	R/W
Parameter group "torque"						
maximum start-up torque	66	value in cNm	*) 16 bit	yes	*)	R/W
maximum torque	68	Applies after completion of start phase (during start phase the value Par. 66 applies); value in cNm	*) 16 bit	yes	*)	R/W
maximum holding torque at end of run	70	value in cNm	*) 16 bit	yes	*)	R/W
maximum holding torque	72	maximum holding torque at standstill in cNm (after completion of the phase "max. holding torque at end of run")	*) 16 bit	yes	*)	R/W

*) Values depend on device type (see following table).

Name	Par. Number	Function	Type/Range	Back up	Delivery State	R/W
Parameter group "time"						
time elapsed until speed falls below speed limit for aborting run	74	value in msec (see also Par. 60)	50...500 16 bit	yes	200	R/W
time period for start-up torque	76	time period at begin of run, in which the "maximum start-up torque" applies (value in msec, see also Par. 66)	10...1000 16 bit	yes	200	R/W
duration of maximum holding torque at end of run	78	time period at end of run, in which the "maximum holding torque at end of run" applies (value in msec, see also Par. 70)	0...1000 16 bit	yes	200	R/W
idle period for direction change	80	idle period when reversing the direction of rotation (value in msec)	10 ... 10000 16 bit	yes	10	R/W
idle period for manual run	82	Span of time a manual run key must be pressed (or a jog run bit must be activated) in order to begin a manual run. Changes only possible when at standstill. (value in steps of 5 msec)	100... 10000 16 bit	yes	1000	R/W
waiting time for brake at end of run	84	time period after the end of run, in which the brake stays released (value in msec) (brake magnet is tightened)	0...3000 16 bit	yes	1000	R/W
UMot filter	86	average time for measuring current power to motor (value in msec)	100 ... 1000 16 bit	yes	100	R/W
Parameter group "others"						
general purpose	88-106	10 general purpose registers	32 bit	yes	0	R/W
Umot limit	108	Lower voltage limit for bit 13 in the status word (failure voltage control); given in 0.1 V increments. Beginning a positioning run or a manual run is only possible if the supply voltage for the motor is higher than the value of this Par. (When the voltage falls below 19.2 V, a power good failure from the hardware will be detected. No positioning is possible, even when the communication may work)	180 ... 240 16 bit	yes	185	R/W
temperature limit	110	upper temperature limit in °C	10...80 16 bit	yes	70	R/W

Name	Par. Number	Function	Type/Range	Back up	Delivery State	R/W
Parameter group "others" (continued)						
delivery state	113	<p><u>writing "-6"</u>: resets the positining system (equals a power-down / power-up sequence)</p> <p><u>writing "-5"</u>: Sets the values of all parameters to the delivery state, saves the parameter into the EEPROM, afterwards positioning to the middle of the measurement range. (IP address and address assigning method stay unaffected) *)</p> <p><u>writing "-4"</u>: Sets the values of all parameters to the values which are saved last by the user, afterwards positioning run to the middle of the selected positioning range" (IP address and address assigning method stay unaffected) *)</p> <p><u>writing "-3"</u>: sets the values of all parameters to the delivery state, erases the IP address, sets the address assigning method to DHCP and saves all parameters in the EEPROM</p> <p><u>writing "-2"</u>: sets the values of all parameters to the values which are saved last by the user, without saving the parameters in the EEPROM</p> <p><u>writing "-1"</u>: sets the values of all parameters to the delivery state, without saving the parameters in the EEPROM (IP address and address assigning method stay unaffected)</p> <p><u>writing "1"</u>: saves all parameters in the EEPROM</p> <p><u>reading directly after boot</u>: 0 → content of memory correct ≠ 0 → content of memory incorrect</p> <p><u>reading after saving</u>: 0 → saving finished successfully ≠ 0 → saving is still in progress or is finished incorrectly (the time for saving is up to 200 msec)</p> <p>Changes only possible when at standstill</p>	-6...-1 or 1 (writing) 0...2 (reading) ±15 bit	no		R/W

*) In cyclic process data exchange, the control word is ignored during a run to the middle of the measurement range (unless it changes). Thus a run to the middle of the measurement range may be interrupted by a change of the control word. Run commands issued before the run to the middle of the measurement range will not automatically restart after finishing the the run to the middle of the measurement range. (I. e. control word 0x14 and old target position will not lead to a run to this position.)

Name	Par. Number	Function	Type/Range	Back up	Delivery State	R/W
Parameter group "others" (continued)						
configuration for connection timeout	118	<p><u>Bits 1-0</u>: configuration for connection timeout (if a connection has been established and lost)</p> <p>0x00: continue moving (drive will continue moving to the actual target position)</p> <p>0x01: drive will abort any positioning</p> <p>0x02: drive will move to the safe position which is defined by Par. 120</p> <p>0x03: reserved</p> <p><u>Bits 3-2</u>: configuration of safe position run when no connection is being established after a certain time at power-up</p> <p>0x00: no safe position run at power-up</p> <p>0x01: safe position run after 15 sec</p> <p>0x02: safe position run after 30 sec</p> <p>0x03: safe position run after 60 sec</p>	16 bit	yes	1	R/W
save position for connection timeout	120	<p>drive will move to this position if</p> <ul style="list-style-type: none"> - a connection loss has been detected and bits 1-0 of Par. 118 are set to 0x02 - no connection is being established after a certain time at power-up and bits 3-2 are being set appropriate 	±31 bit	yes	0	R/W
repetition time for save position run	122	<p>drive will start another save position run if the last save position run was not successful (e.g. because of under voltage, positioning error (block) or over temperature)</p> <p>value in sec; 0 → no repetition</p>	16 bit	yes	0	R/W

3.9.2. Table of rated speed and torque values for various models of gears

device model PSE and PSS		301-x 311-x	302-x 312-x	305-x 315-8	322-14 332-14	325-14 335-14	328-14
Name	Par. No.	value range delivery state					
target speed	52	15...230 230	10...150 150	3...70 70	20...200 170	10...100 85	5...45 45
target speed for manual run	58	15...230 80	10...150 50	3...70 20	20...200 80	10...100 40	5...45 22
acceleration	62	97...600 600	50...400 400	23...130 130	97...525 525	50...260 260	22...100 100
deceleration	64	97...600 600	50...400 400	23...130 130	97...525 525	50...260 260	22...100 100
maximum start-up torque	66	2...125 125	10...250 250	50...600 600	10...250 250	20...500 500	80...960 960
maximum torque	68	2...125 100	10...250 200	50...600 500	10...250 200	20...500 400	80...960 800
maximum holding torque at end of run	70	0...180 60	0...300 100	0...600 200	0...200 70	0...400 140	0...700 300
maximum holding torque	72	0...90 30	0...150 50	0...300 100	0...100 35	0...200 70	0...450 150

device model PSW		301-x 311-x	302-x 312-x	305-x 315-8	322-14 332-14	325-14 335-14	328-14
Name	Par. No.	value range delivery state					
target speed	52	15...180 180	10...125 125	3...60 60	20...150 125	10...80 60	5...35 35
target speed for manual run	58	15...180 80	10...125 50	3...60 20	20...150 80	10...80 40	5...35 22
acceleration	62	97...600 600	50...400 400	23...130 130	97...525 525	50...260 260	22...100 100
deceleration	64	97...600 600	50...400 400	23...130 130	97...525 525	50...260 260	22...100 100
maximum start-up torque	66	2...125 125	10...250 250	50...600 600	10...250 250	20...500 500	80...960 960
maximum torque	68	2...125 100	10...250 200	50...600 500	10...250 200	20...500 400	80...960 800
maximum holding torque at end of run	70	0...180 60	0...300 100	0...600 200	0...200 70	0...400 140	0...700 300
maximum holding torque	72	0...90 30	0...150 50	0...300 100	0...100 35	0...200 70	0...450 150

device model PSW		3218-14	3318-14
Name	Par.-Nr.	value range delivery state	
target speed	52	3...24 20	2...18 15
target speed for manual run	58	3...24 10	2...18 6
acceleration	62	11...70 70	8...45 45
deceleration	64	11...70 70	8...45 45
maximum start-up torque	66	180...2200 2200	250...2000 2000
maximum torque	68	180...2200 1800	250...2000 1800
maximum holding torque at end of run	70	0...1800 600	0...2500 900
maximum holding torque	72	0...900 300	0...1250 450

device model PSE		3110-14	3125-14	3210-14 3310-14	3218-14
Name	Par. No.	value range delivery state			
target speed	52	1...30 30	1...12 12	5...45 38	3...30 28
target speed for manual run	58	1...30 12	1...12 5	5...45 15	3...30 10
acceleration	62	9...50 50	4...20 20	20...117 117	11...70 70
deceleration	64	9...50 50	4...20 20	20...117 117	11...70 70
maximum start-up torque	66	100...1200 1200	250...3000 3000	100...1200 1200	180...2200 2200
maximum torque	68	100...1200 1000	250...3000 2500	100...1200 1000	180...2200 1800
maximum holding torque at end of run	70	0...1200 400	0...2500 900	0...1000 350	0...1800 600
maximum holding torque	72	0...600 200	0...1250 450	0...500 175	0...900 300

device model PSE		338-14	3325
Name	Par. No.	value range delivery state	
target speed	52	8...85 55	2...18 15
target speed for manual run	58	8...85 15	2...18 6
acceleration	62	37...200 200	8...45 45
deceleration	64	37...200 200	8...45 45
maximum start-up torque	66	80...840 840	250...3000 3000
maximum torque	68	80...840 700	250...3000 2500
maximum holding torque at end of run	70	0...700 240	0...2500 900
maximum holding torque	72	0...350 120	0...1250 450

3.9.3. Process data format

1) Output assembly (from the perspective of the EIP scanner)

Assignment:

Byte	Description	Corresponding Par. No.
0-1	control word	3
2-3	not used	
4-7	target value	4
8-9	PKE	5
10-11	IND	6
12-15	PWE	7

2) Input assembly (from the perspective of the EIP scanner)

Assignment:

Byte	Description	Corresponding Par. No.
0-1	status word	8
2-3	actual speed	9
4-7	actual value	10
8-9	PKE	11
10-11	IND	12
12-15	PWE	13

NOTICE
<p>In case the parameter interface (PKE/IND/PWE) is not required, with the help of the EDS file the data length might be reduced from 16 byte to 8 byte for both the output and the input assembly. For this purpose, set Param1 and Param2 to the entry "without Parameter Interface".</p> <p>Hint: Param1 and Param2 always must hold the same entry (e.g. both "with Parameter Interface" or both "without Parameter Interface").</p>

3.9.4. Detailed description of the status bits

Bit 0: target position reached

This bit is set:

- when a transferred target position has been reached successfully (not at the end of a manual run, otherwise the target position is the same as the applicable limit switch)
- after manual displacement while at standstill, if readjustment is activated and the absolute value of the difference of actual and target value is smaller or equal to the positioning window again

This bit is reset:

- after transferring a target position if the difference from the actual value is larger than the positioning window (Par. 40)
- by a manual run
- if an invalid target value has been transferred
- if rotated manually when on standstill

Bit 1: drag error

This bit is set:

- if during a run (except in the braking phase) the difference between actual target position and actual position exceeds the value which has been set with Par. 44

This bit is reset:

- with each new run command

Bit 2: reverse jog key active

This bit is set:

- if Pin 3 on the key connector is connected with Pin 1 (+24V)

This bit is reset:

- if Pin 3 on the key connector is disconnected from Pin 1 (+24V)

Bit 3: forward jog key active

This bit is set:

- if Pin 2 on the key connector is connected with Pin 1 (+24V)

This bit is reset:

- if Pin 2 on the key connector is disconnected from Pin 1 (+24V)

- Bit 4:** STO-enabling active
The behaviour of this bit is depending of the acknowledgement bit (bit 14) in the control word.
- This bit is set (high);
STO-input = high, and if necessary test pulses are valid (and no failure is latched)
- ➔ A latches failure (STO-enabling active = low) is reset (high) when:
 - A new run command is transmitted
 - The acknowledgment bit is toggled (low→high→low)
(if the failure case is still valid, a reset failure is immediately set again)
- This bit is reset (low);
STO input = low or if necessary invalid test pulses (failure case)
- ➔ The status of the STO input is shown
 - The acknowledgment bit is set (high)
 - ➔ The stats of the STO input is latched
 - The acknowledgment bit is reset (low)
and the positioning system is moving (or run command is just transmitted)

NOTICE

Runs which involve specifically a block run (e.g. reference runs on block), may only be started with reduced torque (max. torque max. 10% of the nominal torque).

- Bit 5:** positioning run aborted
This bit is set:
- if a positioning run is aborted because release in the control word has been withdrawn or because of an invalid bit combination in the control word
- This bit is reset:
- with each new run command
- Bit 6:** drive is running
This bit is set:
- when the drive is rotating
- This bit is reset:
- when the drive is on standstill
- Bit 7:** temperature exceeded
This bit is set:
- if the internal device temperature device exceeds the limit value (Par. 110)
- This bit is reset:
- if the internal device temperature falls below the limit value by 5°C
- Bit 8:** movement opposite loop direction
This bit is set:
- after power-up or a reset (a lash in a driven spindle which might be present is not yet eliminated)
- when commanding a positioning run or a manual run in opposite of the loop direction
- when commanding a positioning run or a manual run, when no loop is configured (Par. 42 is zero)
- This bit is reset:
- when a transferred target position has been reached successfully in the loop direction (not after a manual run)

- Bit 9:** error
This bit is set:
 - if an internal problem is detected when calculating a position
 - STO hardware failure (STO-input is invalid =low / missing test pulses) and a motor current flow.
 No run commands can be executed when the error bit is set!
This bit is reset:
 - only possible by resetting or power-cycle the drive
- Bit 10:** positioning error (block)
This bit is set:
 - if a positioning run or a manual run is aborted because the device is overloaded (block, extreme difficulty while running)
This bit is reset:
 - with each new run command
 - by a 0-1 edge of the acknowledgement bit (bit 14) in the control word
- Bit 11:** manual displacement
This bit is set:
 - if, while on standstill, the drive is turned externally by more than the value in the positioning window after a positioning run has been finished correctly
This bit is reset:
 - with each new run command
 - by a 0-1 edge of the acknowledgement bit (bit 14) in the control word
- Bit 12:** incorrect target value
This bit is set:
 - when a transferred target value lies outside of the limit switches; also caused, for instance, because of the actual value of the referencing value (Par. 32)
 - when a transferred target value lies inside of the limit switches; but because of a necessary loop run the specified interval would be left
This bit is reset:
 - with each new run command
 - by a 0-1 edge of the acknowledgement bit (bit 14) in the control word
- Bit 13:** Voltage control valid
 The behaviour of this bit is depending of the acknowledgement bit (bit 14) in the control word.
This bit is set (high):
 - The supply voltage is lower than U_{mot} limit (SDO 203C)
 - or the supply voltage is > 30 V
 - or the voltage control circuit reports an failure (Power Good = FAIL)
 → Acknowledgment Bit is reset (low)
 The status of the failure condition is shown
 → Acknowledgment bit is set (high)
 The failure condition is latched
This bit is reset (low):
 - The supply voltage is higher than U_{mot} limit (SDO 203C)
 - And the supply voltage is <30 V
 - And the voltage control circuit reports no failure (Power Good = PASS) (and no former failure is latched)
 → A latched failure (Voltage control valid=high) is reset when:
 - A new run command is transmitted
 - The acknowledgment bit is toggled (low→high→low)
 (if the failure case is still valid, a reset failure is immediately set again)

Bit 14 / 15: positive / negative range limit

This bit is set:

- if the limit value is reached during a manual run (but not if reached during a positioning run)
- if a limit value is modified such that the current position lies beyond the limit
- if, while on standstill, by means of an external force the drive is moved to a position which is outside the area which is defined by the range limits

This bit is reset:

- as soon as the actual position is again inside the range limits (Exception: After the end of a manual run the drive is located still at the range limit within the positioning window and no new run command was issued yet.)

3.9.5. Detailed description of control bits

Bit 0: manual run to larger values

Bit 1: manual run to smaller values

Bit 2: transfer target value

The target value in the process data is being accepted as a new valid target value, if this bit is set. A positioning run which starts simultaneously or later uses this target value as new target position. If together with taking over the target value the positioning run shall start immediately, bit 4 ("release") has to be set additionally.

If bit 2 is not set, the target value will not be taken over, instead there might be a positioning run to the target value which has been sent at last and which has been marked as valid.

Bit 3: Enable manual movement in jog mode:

In jog mode (movement by keys if bit 5 is set; or with bit 8 or 9 set in the control word if bits 4 and 5 are not set). Manual movement is only activated if bit is set, when the key is pressed for a long time (or a jog movement bit is activated for a long time). If the bit is cleared, only single steps are possible in jog mode.

Bit 4: Release

Run commands will only be executed if this bit is set.

This bit must be set for positioning runs and manual runs.

If this bit is cleared during a run, the run will be aborted and status bit 5 will be set ("positioning run aborted").

Bit 5: Enable jog mode with keys:

If the bus connection is active, jog mode via keys is only possible if this bit is set and bit 4 is not set. For jog operation via bus (bits 8 or 9 in the control word), this bit must not be set.

Bit 6: Driving without a loop

If this bit is set, all destinations are approached directly during positioning movements (regardless of the current value of par. 42) without any loop.

Bit 7: Execute switch-on loop
5/8 turns against loop direction and then 5/8 in loop direction with manual speed (for default value of loop length par. 42). The control word is ignored during a switch-on loop movement until it changes. Thus a switch-on loop can be aborted with control word = 0.

Bit 8: Jog to larger values:
Corresponds functionally to a pressed key forward (bit 3 in status). Bits 4 must be set in this operating mode!

Bit 9: Jog to smaller values:
Functionally corresponds to a pressed key backwards (bit 2 in status). In this operating mode, bit 4 must be set and bit 5 must not be set!

Bits 10-13: reserved, must be programmed to 0

Bit 14: Acknowledgement bit
Is cleared (low):
- Bit 4 and 13 of the status register show the current status of the STO input or the voltage monitoring input.
Is set (high):
- Bit 4 and 13 of the status register are latches to 0 in the case of a failure, and if the positioning system is moving or a run command is transmitted (if the system is not moving, and no running command is transmitted Bit 4 and 13 of the status register shows the actual state)
Rising edge (low → high)
- Bit 5, 10, 11 and 12 of the status register are cleared.

Bits 15: reserved, must be programmed to 0

3.9.6. Parameter interface

Via the parameter interface it's possible to write and read parameter values by using the cyclic process data connection, besides, also other values might be retrieved from the drive.

With the help of the parameter interface the EIP scanner sets and transmits a new command. It repeats this command cyclically until the drive has processed the command and has sent back an answer. The drive provides this answer until the EIP scanner formulates a new command. A parameter value that's being sent back by the drive as an answer to a read request, refers to the moment at which the EIP scanner has been issued the command. I.e. in case of a parameter value that should be monitored for a longer time, the EIP scanner has to send another command after taken over the actual parameter value. This takes place by setting the request identifier 0 ("no request") and subsequent waiting, until the drive confirms this request with the response identifier 0 ("no response"). Afterwards the same parameter value might be requested again.

One drive can only process one request at a time.

Structure of the parameter interface:

Parameter interface							
PKE		IND		PWE			
0	1	2	3	4	5	6	7

PKE = Parameter identifier

IND = Index

PWE = Parameter value

Structure of the parameter identifier PKE:

The information "parameter identifier" (PKE) consists of a data word (byte 0 and 1 of the parameter interface), in which the type of the request (or the response) and the related parameter number are coded:

Parameter identifier PKE															
Bit No.															
15	14	13	12	11	10	9	8	7	6	5	4	3	2	1	0
AK				SPM		Parameter number (PNU)									

AK = request identifier or response identifier

SPM → not used, set to 0

PNU = Parameter number

The parameter number (PNU) refers to the table above ("Table of implemented parameter entries (class 0x64; instance 1)").

Request identifier (EIP scanner → drive):

Request identifier	Function	Possible response identifier of drive *)	
		positive	negative
0	No request	0	7
1	Request parameter value	1 or 2	
2	Modify parameter value (word)	1	
3	Modify parameter value (double word)	2	
6	Request parameter value (array)	4 or 5	
7	Modify parameter value (array, word)	4	
8	Modify parameter value (array, double word)	5	
9	Request number of array elements	6	

)* The column “response identifier” contains the possible responses for a certain request, distinguished between a successful completion of the request (“positive”) or an error (“negative”).

Response identifier (drive → EIP scanner):

Response identifier	Function
0	No response
1	Transfer parameter value (word)
2	Transfer parameter value (double word)
4	Transfer parameter value (array, word)
5	Transfer parameter value (array, double word)
6	Transfer number of array elements
7	Cannot process request (with error number)

Subindex IND:

For requests and responses which refer to array elements, the field IND contains the array subindex.

Parameter value PWE:

This field contains the numerical value which belongs to the related parameter.

When a request cannot be completed successfully (e.g. response identifier AK = 7), the drive reports an error code according to the following table:

Error code	Meaning
0	Illegal parameter number
1	Parameter value cannot be modified
2	Minimum/maximum limit exceeded
3	Faulty subindex
4	No array
5	Incorrect data type
6	Setting not allowed (resetting only)
17	Request cannot be processed due to operating state
18	Other error

When a write request is being completed successfully (e.g. request identifier AK = 2, 3, 7 or 8) the response contains the same data as a read request of this parameter. The response identifier then is one of the values 1, 2, 4 or 5, depending on the data type. The parameter number PNU, the index IND and the parameter value PWE are the same as given in the request. Hence it is possible to check again that the drive actually took over the requested values.

4. Sequence of positioning

4.1. Positioning sequence with loop

By default, the PSx3xx always approaches each setpoint from the same direction. If a destination is in the opposite direction to the loop direction, the setpoint is first traversed by the value of the loop length (Par. 42) and then finally approached. This can, for example, eliminate the backlash of a driven spindle.

The PSx3xx thus distinguishes the following cases during a positioning process:
Assumption: Each target position is approached in forward direction, i.e. the loop length is - 250 steps = 5/8 revolutions.

1. New setpoint position is greater than the current actual position: The target is approached directly.

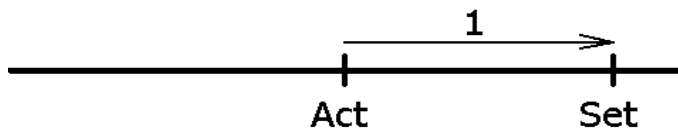

2. New setpoint position is smaller than the current actual position: The device is moved further back by the loop length (2a) and the final destination is then approached in forward motion (2b).

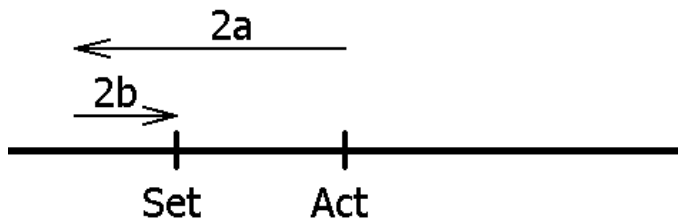

3. New setpoint position is only slightly larger than the current actual position and previously there was no positioning movement with loop (e.g. a manual movement): In all cases, the drive approaches the target with a forward movement whose length corresponds at least to the loop length. In order to achieve this, the drive first moves in reverse direction (3a), i.e. against the actually desired direction of travel, and then forwards the actual destination (3b).

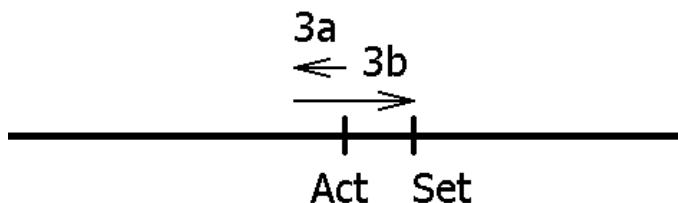

The maximum length of this distance is the loop length. If the setpoint differs from the current actual value by more than the loop length, it is approached directly.

After reaching the target position, this position is compared with the internal absolute encoder status. If there is a deviation, the status bit "Error" is set (bit 9 in the status word).

In the delivery state, the loop length is -250 steps, i.e. each setpoint position is approached in the forward direction.

NOTICE

A positioning to the upper end limit (Par. 36) with a loop length >0 is not possible, since the drive would have to cross the end limit for this. The same applies to the lower end limit (Par. 38) with a loop length <0 .

4.2. Positioning sequence without loop

The mode "positioning without loop" mode is used primarily for moving the small distances involved in fine adjustments. In this case, each position is approached directly. This does NOT eliminate any play present in the spindle in question. The PSx3xx internal gear backlash does not play a role in this case, as position data are acquired directly at the output shaft.

5. Specials

5.1. Speed, acceleration and deceleration

Manual runs are performed at the maximum speed specified in Par. 58; positioning runs are performed at the maximum speed specified in Par. 52. For all runs the maximum acceleration in Par. 62 and the maximum deceleration in Par. 64 apply. At the end of each run the maximum deceleration decreases during the approach to the destination successively in order to realize a harmonic transient behaviour.

A stop command causes the drive to brake with the maximum deceleration, independently of the setting in Par. 64.

5.2. Maximum starting torque and maximum torque

Via Par. 66 the maximum starting torque can be set, via Par. 68 the maximum driving torque.

The starting torque is active for the period in Par. 76 after each start of travel. It should always be slightly higher than the driving torque, since the drive requires more torque for the acceleration phase than for constant driving.

Both values are not sharp torque limits, instead the motor current is limited to a value, which corresponds to the current consumption at the nominal speed at the set torque. If a lower speed than the rated speed is set, the achievable torque is slightly higher than at the (default) nominal speed.

NOTICE

If small torque limits are to be used, it must be considered not to use these in combination with high speed values, as this can lead to unstable driving behaviour!

5.3. Response of drive in case of block

If during a run due to load the speed falls below the threshold parameter of 30% of the selected maximum speed (Par. 74) for longer than 200 msec (Par. 60), the device detects blocking, aborts the run and sets the "positioning error" bit (here the default values are given). The drive from now on stands with the selected holding torque (Par. 72).

New run commands can then be transmitted with no further steps to take, i.e. transmitting a target value (change of the target value in the process data) starts a new run.

An exception is (in case the drive is controlled with the help of process data), if the run should go to the same target than before. In this case, deassert the release (bit 4 of the control word) and assert it again. Bit 2 ("transfer target value") has to be set at the same time. The drive then moves on when the release bit is being asserted again.

In case the drive is controlled with pure UCMM instead of a cyclic process data connection, deasserting and asserting the release bit by setting Par. 3 does not cause a new run. The (old or new) target value has to be sent explicitly by setting Par. 4.

NOTICE

Runs which involve specifically a block run (e.g. reference runs on block), may only be started with reduced torque (max. torque max. 10% of the nominal torque).

5.4. Behaviour of the actuator during manual rotation (readjustment function)

If after a correctly finished positioning run (or a manual run to the range limit) during standstill the PSx3xx is displaced by external force opposite to the loop direction and the release bit (bit 4 in the control word) is set and the readjustment function (Par. 46) is enabled. The device will attempt to reach the previously transmitted target value once again (readjustment). After successful readjustment bit 0 will be set again. The device does not attempt to readjust if rotated in the loop direction; it merely sets bit 11 in the status word ("manual displacement") and resets bit 0 ("target position reached"). If the loop run is disabled (Par. 42 is 0), the drive readjusts the position in both directions.

NOTICE

If at standstill the drive continuously loses its position, the attempt to readjust starts exactly when the actual position is leaving the positioning window (assumed that all the conditions above are being fulfilled). The motor power has to be in a valid range at the time when this transition happens (e.g. Bit 4 in the status word is being set). If the motor power is missing at that time, the readjustment fails and bits 10 ("positioning error") and 13 ("motor power was missing") will become active. If later the motor power comes back again (after leaving the positioning window), there will be no further attempt to readjust. This is to prevent a situation that suddenly a drive begins to run if motor power is being switched on.

If an ongoing positioning run or manual run is aborted (release bit in the control word to 0), the drive readjusts the position not before a new run is being sent and finished successfully.

Deasserting the release bit and/or disabling the readjustment function can completely disable the readjustment process.

Drives with a brake generally don't have a readjustment function.

5.5. Calculating the absolute physical position

The PSx3xx actuator includes an absolute measuring system with measurement range of 256 rotations. In order to avoid an overflow when the drive is switched off and moved by an external force, the user can only command positionings in the range of 250 rotations. Thus, the upper as well as the lower 3 rotations of the measurement range are inaccessible.

The mapping of the desired positioning range to the physical positioning range is done with the help of the parameter “upper mapping end” (Par. 34).

In the delivery state, the drive is at position 51200, the upper limit switch is set to 101200 and the lower limit switch is set to 1200, yielding a positioning range of ± 125 rotations (± 50000 increments). So if the desired positioning range doesn't exceed ± 125 rotations, in delivery state none of the following actions to adjust the positioning range have to be taken.

For the realization of any desired positioning range independent of the possible positioning range, which is defined by the mounting situation (physical positioning range), there are the following two possibilities:

- 1) Move the axle (for example a spindle) to the desired position, then move the drive (with opened collar) to the position value which belongs to the physical position of the axle, only then close the collar.

Examples:

- a) Move the axle in middle position, then move the drive at no-load (with opened collar) also to middle position (position 51200), then close the collar. The drive is now capable of moving 125 rotations (± 50000 increments by default) in each direction.
- b) Move the axle completely to the left (resp. bottom), then move the drive at no-load (with opened collar) without loop to the lowest position (position 1200), then close the collar. The drive is now capable of moving 250 rotations (± 100000 increments by default) to the right (resp. top).
- c) Move the axle completely to the right (resp. top), then move the drive at no-load (with opened collar) to the highest position (position 101200), then close the collar. The drive is now capable of moving 250 rotations (± 100000 increments by default) to the left (resp. bottom).

- 2) Mount the drive in any position on the axle, close the collar, then adjust the positioning range with the help of Par. 34. Par. 34 defines the upper end of the positioning range. By default, the upper end is at +256 rotations (position 102400). If the positioning range doesn't suit to the actual displayed position after mounting the drive, the upper end of the positioning range can be adjusted freely between +3 rotations and +253 rotations (measured from the actual position).

Examples:

- a) After mounting the drive, the displayed position is 51200 (which corresponds the delivery state). But the positioning range shall solely spread to the right (resp. top).
 - upper mapping end = actual position + 253 rotations
 - Set Par. 34 to 152400
- b) After mounting the drive, the displayed position is 100000. But the positioning range shall solely spread to the right (resp. top).
 - upper mapping end = actual position + 253 rotations
 - Set Par. 34 to 201200
- c) After mounting the drive, the displayed position is 2000. But the positioning range shall solely spread to the left (resp. bottom).
 - upper mapping end = actual position + 3 rotations
 - Set Par. 34 to 3200

Remarks:

- 1) When calculating the upper mapping end (Par. 34), a security reserve of 3 rotations has to be kept in mind (1200 increments by default, see the examples above), because the highest possible position value is 3 rotations below the upper mapping end. The lowest possible position value is 253 rotations below the upper mapping end.
- 2) The above given increment and position values relate to the following settings, which correspond to the delivery state:
 - a) position scaling, numerator (Par. 28) = 400
 - b) position scaling, denominator (Par. 30) = 400
 - c) referencing value (Par. 32) = 0
 These 3 parameters have an influence on the above given increment and position values: With the help of the referencing value a shift can be reached, with the help of the position scaling numerator and denominator a stretching or distension can be reached (see below).
- 3) When changing the direction of rotation (Par. 26), the referencing value (Par. 32), the upper mapping end (Par. 34) and the upper and lower limit (Par. 36 and 38) are set to delivery state.
- 4) When changing the upper mapping end (Par. 34), the upper limit (Par. 36) will be set to the value [upper mapping end - 3 rotations x scaling] and the lower limit (Par. 38) to the value [upper mapping end - 253 rotations x scaling]. This results in a positioning range of 250 rotations.
- 5) When changing the position scaling numerator or denominator (Par. 28 or 30), the target value, the actual value, the referencing value, the upper mapping end, the upper and lower limit, the drag error, the positioning window and the length of loop are re-calculated.
- 6) When changing the referencing value (Par. 32), the target value, the actual value, the upper mapping end and the upper and lower limit are re-calculated.
If the values of the upper mapping end (par. 34) and/or the limit switches (par. 36, 38) are sent by default each time the unit starts up, the new referencing value must be included in these values if necessary. This can be done, for example, by defining base values (which apply in the case of "referencing value = 0"), to which the respective current value of the referencing value is then added.
- 7) If the user wants to go over any automatic re-calculation of values when setting up the device, the optimum order of transferring the parameter is the following:
 - a) direction of rotation (Par. 26),
position scaling, numerator (Par. 28),
position scaling, denominator (Par. 30)
 - b) referencing value (Par. 32)
 - c) upper mapping end (Par. 34)
 - d) upper limit (Par. 36),
lower limit (Par. 38),
positioning window (Par. 40),
length of loop (Par. 42),
drag error (Par. 44)
- 8) In order to save the settings permanently in the EEPROM, write 1 to Par. 113. As soon as reading of Par. 113 shows 0, the saving is finished.

Referencing value (Par. 32):

With the help of the referencing value (Par. 32) a shift of the whole range of values can be reached. The referencing process affects all transferred values, i.e., the target value, actual value, upper mapping end and upper and lower limit.

There are two ways of setting the referencing value:

- 1) Directly, by writing the referencing value to Par. 32.

- 2) Indirectly, by writing an actual value to Par. 10. This makes it possible to assign any “true” actual value to the current, physical actual value. The resulting difference is then the referencing value. This value will immediately be included in calculations for each transferred value and can also be read via Par. 32. When changing the referencing value, automatically the target value, the actual value, the upper mapping end and the upper and lower limit are recalculated.

5.6. Use of the “Upper mapping end” parameter

The following chapter illustrates the use of the parameter “upper mapping end” both graphically and by means of examples:

5.6.1. Delivery state

In the delivery state (“DS”), the actual position is exactly in the middle of the positioning range. There is a safety margin of three rotations at the output shaft at both the lower and upper ends of the positioning range. Positioning runs that extend into these safety margins are rejected by the device with the error “Incorrect target value”.

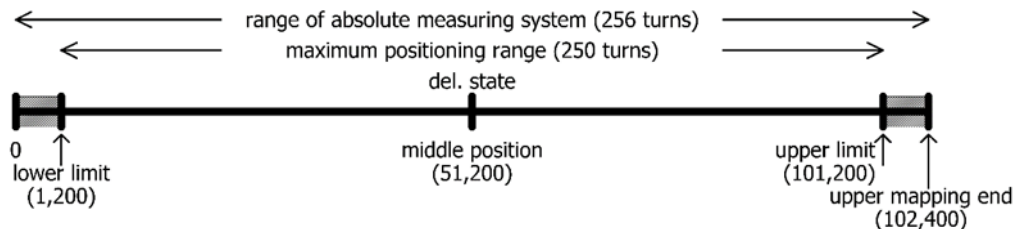

In the delivery state, the values from the following table result for the upper mapping end and the lower and upper limits:

Upper mapping end	102,400
Lower limit	1,200
Upper limit	101,200

Positioning range symmetrical to 51,200

Starting from this state, the maximum possible positioning range can now be shifted upwards or downwards as required.

It is important to note that after the device has been installed, the available positioning range may not be sufficient in one of the two directions. The parameter “upper mapping end” now allows you to reduce the positioning range in one direction and increase it in the other direction.

5.6.2. Shifting the positioning range upwards starting from the delivery state

In the following example, starting from the DS, the maximum possible positioning range is shifted slightly upwards using the parameter “upper mapping end”:

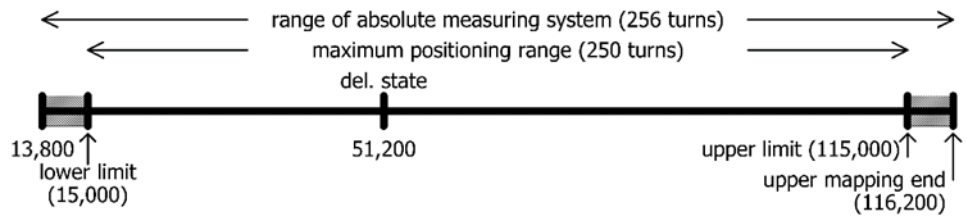

Here, the upper mapping end was increased from the value 102,400 to 116,200. Consequently, a higher proportion of the possible positioning range is above 51,200 and a smaller proportion below 51,200.

In the extreme case, the upper mapping end can be set so that the entire possible positioning range is at values $\geq 51,200$. With standard scaling (numerator = denominator = 400, i.e. 1 step = 0.9°) and referencing value = 0, this special case results if the relevant value from the following table is selected for the upper mapping end. The device then automatically adjusts the lower and upper limits accordingly.

Upper mapping end	152,400
Lower limit	51,200
Upper limit	151,200

Positioning range starts at 51,200

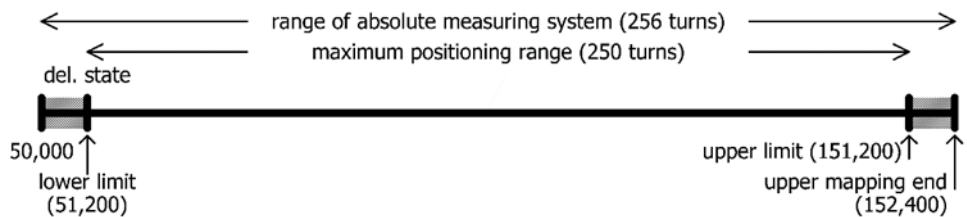

NOTICE

The numerator factor and denominator factor can be used to map any spindle resolutions. Using the referencing value, you can shift the whole range of values.

5.6.3. Shifting the positioning range downwards starting from the delivery state

In the following example, starting from the DS, the maximum possible positioning range is shifted slightly downwards using the parameter “upper mapping end”:

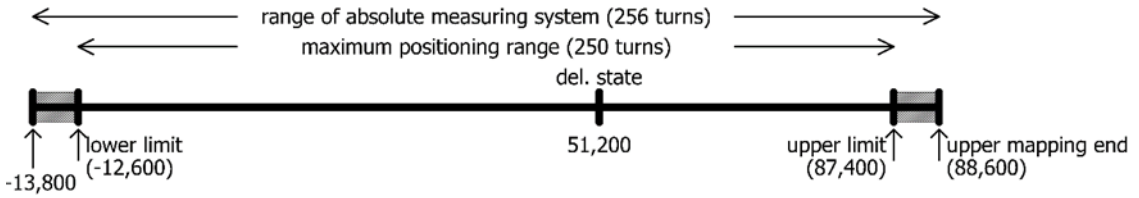

Here, the upper mapping end was decreased from the value 102,400 to 88,600. Consequently, a higher proportion of the possible positioning range is below 51,200 and a smaller proportion above 51,200.

In the extreme case, the upper mapping end can be set so that the entire possible positioning range is at values $\leq 51,200$. With standard scaling (numerator = denominator = 400, i.e. 1 step = 0.9°) and referencing value = 0, this special case results if the relevant value from the following table is selected for the upper mapping end. The device then automatically adjusts the lower and upper limits accordingly.

Upper mapping end	52,400
Lower limit	-48,800
Upper limit	51,200

Positioning range ends at 51,200

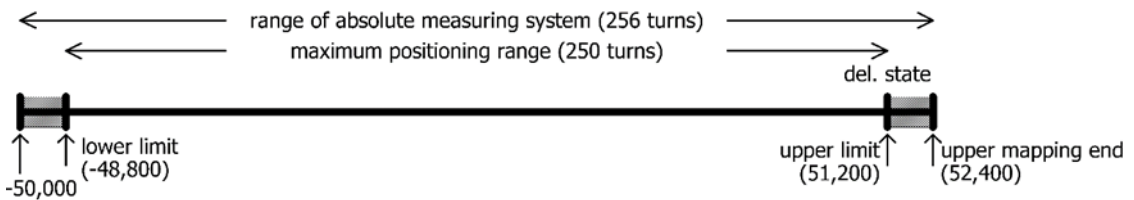

5.6.4. Shifting the positioning range depending on the actual position

If (in contrast to the examples above) the actual position is not in the delivery state (i.e. value 51,200), this is included in the calculation of the possible value range for the upper mapping end. The decisive factor is that the device only accepts values for the upper mapping end where the actual position is within the max. possible positioning range after the upper mapping end has been set (due to rounding effects with a max. difference of 1 step), i.e. the following applies after setting the upper mapping end:

$$[\text{lower limit} - 1] \leq \text{actual position} \leq [\text{upper limit} + 1]$$

Please note that the measurement range of the absolute encoder is 256 rotations at the output shaft. Together with the safety margins at the upper and lower end of the measurement range, the following value range results for the upper mapping end:

$$\text{Minimum value for upper mapping end} = \text{actual position} + 1,200 * \text{denominator} / \text{numerator}$$

$$\text{Maximum value for upper mapping end} = \text{actual position} + 101,200 * \text{denom.} / \text{numerator}$$

The following formulas result for the special case numerator = denominator:

$$\begin{aligned} \text{Minimum value for upper mapping end} &= \text{actual position} + 1,200 \\ \text{Maximum value for upper mapping end} &= \text{actual position} + 101,200 \end{aligned}$$

(This is the case, e.g. for the delivery state where numerator = denominator = 400.)

NOTICE

Since the upper mapping end is an integer, the minimum and maximum values are obtained by rounding to the nearest integer (applies only to the case numerator \neq denominator).

Example:

- Spindle with 5 mm pitch, specified unit for target and actual values: 1 μ m
 → 1 rotation = 5mm = 5,000 μ m
 → Number of steps per rotation = 5,000
- Using the formula
 *Number of steps per rotation = 400 * denominator / numerator*
 the following result is obtained:
 numerator = 400; denominator = 5,000
- With these settings, the drive is mounted and run using manual positioning commands, to a defined physical position (e.g. a specific mark along the run path) at which the actual position is to assume a specific value, e.g. the value 0.
- In our case, the position after running to this defined physical position shows, for example, the value 300,000. In this position, the actual value is set to zero. The device uses this information to calculate the new referencing value at 300,000.
 → Referencing value = 300,000
- The drive has a positioning range of 250 rotations (see above: Measurement range of the absolute encoder minus a safety margin of three rotations at both ends of the measurement range).

- In our case, these 250 rotations are to be divided in such a way that the drive can run 10 rotations (= $10 * 5,000$ steps = 50,000 steps) from the zero position, just defined, to smaller values and 240 rotations (= $240 * 5,000$ steps = 1,200,000 steps) to larger values.
- To ensure that the position value 1,200,000 is at the upper end of the maximum possible positioning range, as specified (i.e. at the upper limit), we add the safety margin of three rotations to this value and thus obtain our value for the upper mapping end:
upper mapping end = $1,200,000 + 3 * 5,000 = 1,215,000$
- The device then recalculates the positioning range limits:
lower limit = upper mapping end - $253 * 5,000 = -50,000$
upper limit = upper mapping end - $3 * 5,000 = 1,200,000$
- This positioning range can then be restricted as required, i.e. the lower limit can be increased and the upper limit can be reduced.

5.6.5. Step-by-step instructions for determining the positioning range

The following section describes the procedure for determining those parameters that have an influence on the target and actual position as well as the positioning range. The individual steps must be carried out in the specified order.

1) Setting the direction of rotation:

The direction of rotation determines with which direction of rotation of the output shaft the position values increase and with which direction of rotation of the output shaft the position values decrease.

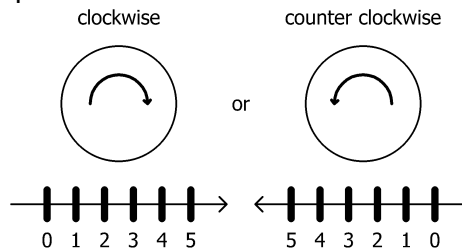

2) Setting numerator and denominator:

The numerator and denominator determine the number of steps into which one rotation of the output shaft is divided.

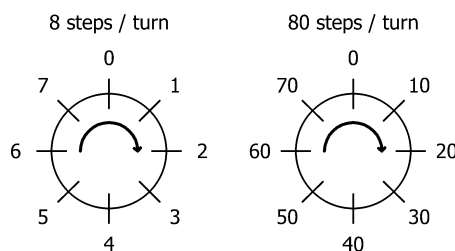

3) Setting referencing value:

The referencing value is used to assign a specific value of the actual position to a specific physical position of the axle.

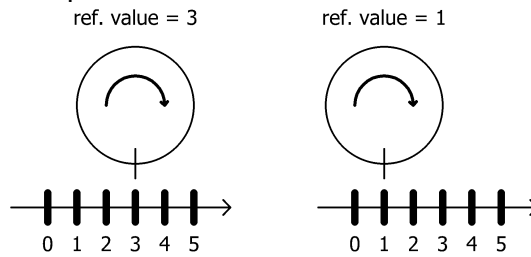

The referencing value is written either directly or by setting the actual position.

4) Setting upper mapping end:

The parameter defines the location of the maximum possible positioning range, taking into account the scaling values and the referencing value.

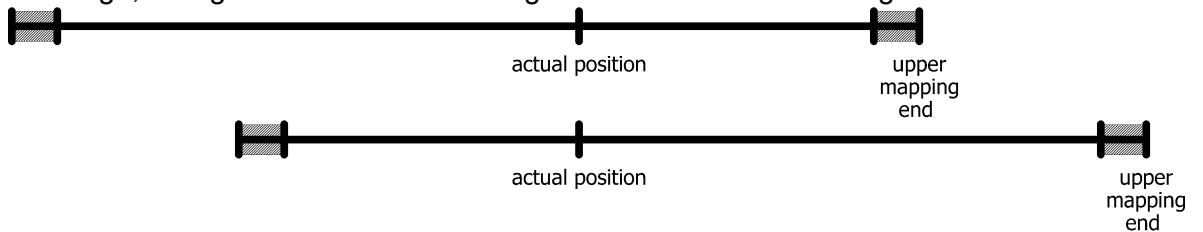

5) Setting upper and lower limits:

If necessary, the maximum possible positioning range can be restricted to prevent incorrect target positions that lead to a collision.

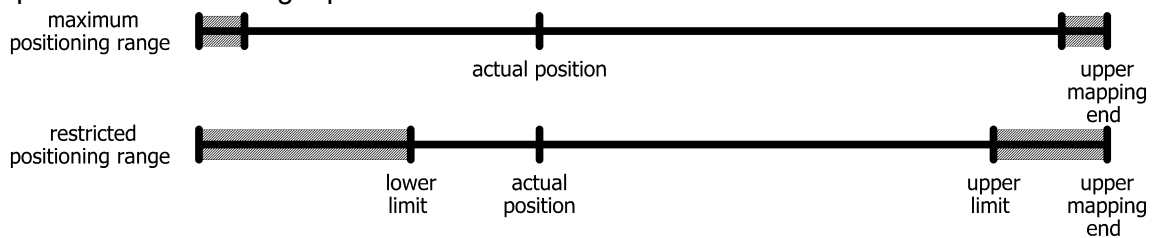

5.7. Using position scaling factors to set the spindle pitch

Par. 28 (numerator factor) and Par. 30 (denominator factor) can be used to represent any desired spindle pitch:

$$\text{number of steps per revolution} = 400 * \frac{\text{denom. factor}}{\text{numerator factor}}$$

Both factors are set to a value of 400 by default, resulting in a resolution of 0.01 mm at a spindle pitch of 4 mm.

The denominator factor serves as a simple means of setting the spindle pitch and resolution.

The numerator factor is primarily used for setting “uneven” resolutions.

Examples:

Spindle pitch	Resolution	Numerator factor	Denominator factor
4 mm	1/100 mm	400	400
1 mm	1/100 mm	400	100
2 mm	1/10 mm	400	20

Numerator and denominator factors may take on values between 1 and 10,000.

5.8. Drag error monitoring

During a positioning run, the device compares the computed target position with the current actual value. If the difference is larger than the "drag error" value (Par. 44), the device sets the corresponding bit in the status word. This situation is especially likely to occur if external factors (required torque, voltage to motor too low) prevent the device from achieving the target rpm.

By setting Par. 44 to 0 the drag error monitoring can be disabled.

5.9. Drag error correction

With Par. 48 the drag error correction can be enabled. With this feature enabled, the drive will raise or lower the target speed proportional to the drag error by the configured value. The drive attempts under consideration of the configured maximum current to compensate the drag error which has developed by controlling the target speed to a value which lays slightly above or below the specified value of the target speed (Par. 52).

By setting Par. 48 to 0 the drag error correction can be disabled.

Drag error monitoring and correction take effect always except during a braking operation when approaching a target position or when aborting a positioning. The actual target speed when accelerating is determined by the actual speed at the beginning of the positioning and the acceleration setting (Par. 62).

5.10. Abort run when the master fails

It is not possible for the master to abort a started movement if the connection to the master is interrupted during positioning. In this case, for example, in order to generate an automatic trip interruption, there is a supervision of the communication to the IO-Controller in the drive. A timeout triggers an interruption of travel. If the process data contain valid values when the connection is re-established, the drive continues to run immediately if necessary

Three possible reactions are provided in the event of a connection failure:

- 1) If a positioning is in progress, the drive should terminate this positioning as planned and then not start a new positioning as long as there is no connection.
→ This behaviour is enabled when par. 118 ("Configuration for connection failure") is set to 0.
- 2) If a positioning is in progress, the drive should abort the movement and then not start a new positioning as long as there is no connection.
→ This behaviour is activated when par. 118 ("Configuration for connection failure") is set to 1 ("Abort movement").
- 3) Irrespective of whether the drive is at a standstill or whether positioning is in progress, the drive is to move to the safety position defined in par. 94.
→ This behaviour is enabled when par. 118 ("Configuration for Connection Failure") is set to 2 ("Move to Safe Position").
The safe position move can also be started repeatedly in case of failure, this is configured by par. 122 ("Repeat time for safety move").

5.11. Devices with "Jog keys" option

External jog buttons can be used to move the drive when the bus connection is inactive.

When the bus connection is active, the external jog buttons can be enabled via bits 3 and 5 in the control word (see section 3.11.5 Detailed description of control bits).

The step size for short keystrokes can be set via parameter 50. A single step is executed when one of the external keys is pressed. If the key is released before the single step has been completed, it will still be completed. If the same key remains pressed, the single step may be followed by a continuous manual movement after a short waiting time, which continues as long as the key is pressed. The waiting time until the drive changes over to manual travel is set with parameter 82. In manual travel, the drive moves to the respective limit switch position (parameter 36 or 37).

If both keys are pressed during a jog movement, the movement is aborted immediately. A new inching movement is only possible again when both keys have been released.

Connecting the Jog Key Inputs

The jog key inputs can be used in 2 different wiring modes:

- Connection of potential-free switches

To activate the respective jog key input, the +24V in the jog key plug is connected here.

The GND connection in the jog key plug remains unused.

The 24V output in the jog key plug is internally connected to the +24V control in the supply plug. It is therefore also possible to connect the jog button inputs directly to the +24V control potential via switches.

- Connection of an active signal

Here the respective jog key input is connected to the (active) signal connection.

The reference ground of the external active signal should be connected to the GND connection in the jog key plug.

The +24V output in the jog key plug remains unused.

The GND connection in the jog key plug is internally connected to the GND control in the power supply plug. If the connected active jog key signal has the same GND potential as the GND control, the wiring of the GND connection in the jog key plug can be omitted.

Connection examples:

potential-free switches

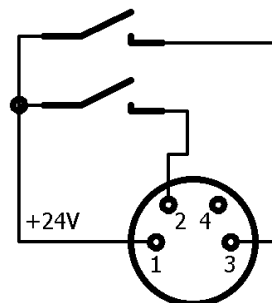

active signals e.g. from a PLC

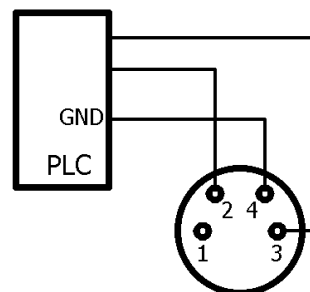

5.12. Manual turning with the adjustment facility

When mounting or dismounting a PSx3xx, it may be necessary to manually turn the output shaft to a certain position. For this purpose, the actuators are equipped with a manual adjustment facility:

First, the corresponding cover in the cover must be removed.

Then use a NW3 (PSx31x, PSx33x, or NW4 (PSx30x, PSx32x) hexagon key to disengage the brake by pressing it down and turn it simultaneously.

An electrical release of the brake via bus is not possible on its own (without travel job).



CAUTION

The drive must not be turned into another position with an electric screwdriver.



CAUTION

Important: Always replace the protective cap after setting the address. This will prevent dust and contaminants from entering the instrument.



CAUTION

A "forced" turning of the drive without disengaging the brake leads to the destruction of the brake and thus of the drive!

5.13. Devices with optional snap brake

The device models PSx30x-14, PSx31x-14, PSx32x and PSx33x can be supplied with an optional snap brake. This brake prevents the output shaft from turning when the power supply to the motor is removed, or, if the motor holding torque is too low, to a maximum of the level of the nominal torque. A small degree of rotation always occurs at the output, i.e. the brake cannot be used to hold the drive at a defined position (for this purpose where appropriate the holding torque might be increased with the help of Par. 70 and Par. 72).

To release the brake when a run command is transmitted, these devices first wait for a short time and then run a few increments against the actual direction of movement. The brake is closing at the end of every run (by default 1 sec after the end of the run, Par. 84). The advantage of this feature is, that in case of many subsequent runs the brake has not to be released anew each time.

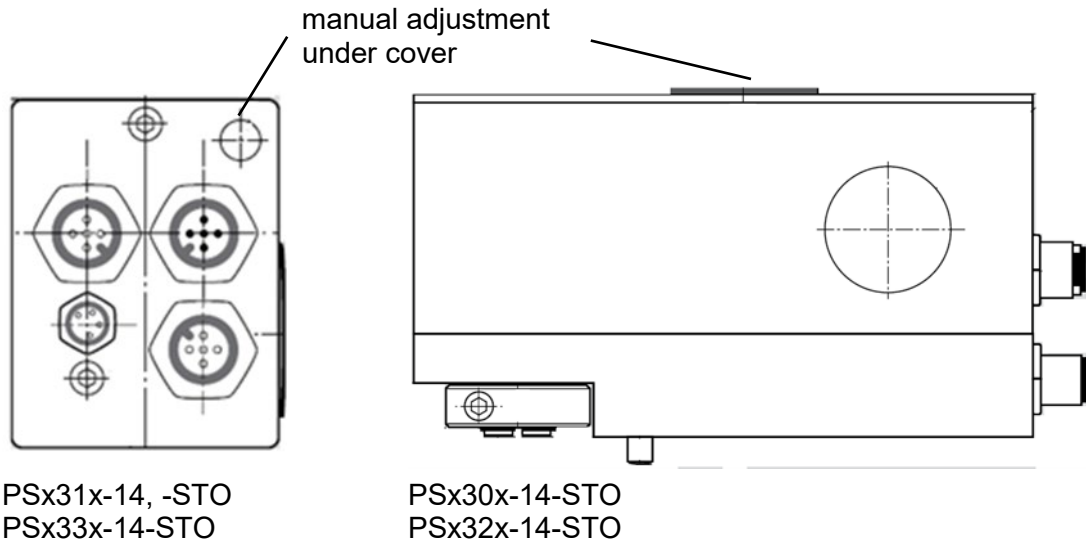

5.14. Reference runs

The PSx3xx positioning system is equipped with an absolute measuring system, therefore there's no need for a reference run when powering on the drive. However, if in certain cases a reference run onto a hard block should be desired (e.g. uniquely when installing the drive at a machine), the course of action should be the following:

- 1) Before commanding the reference run the following settings have to be carried out:
 - set the maximum torque (Par. 68) and the maximum start-up torque (Par. 66) to max. 10% of the nominal torque, resp. the lowest possible values
 - set the maximum holding torque (Par. 72) and the maximum holding torque at end of run (Par. 70) to 0
 - set the rpm limit for aborting run (Par. 60) to 60
 - set the time elapsed until speed falls below rpm limit for aborting run (Par. 74) to 100
(The span of time in which the drive tries to get over the block, decreases: With the reduced values the positioning will be aborted if the speed stays below 60% of the target speed for longer than 100ms. By default, these values are 30% and 200ms.)
 - set the corresponding upper and lower limit (Par. 36 or 38) in a way that the block location lays considerable within the area between the upper and lower limit
(Otherwise there's the danger that the block is located within the positioning window and consequently won't be recognized.)
 - Where appropriate, reduce the target speed for manual run (Par. 58).
- 2) Now start the reference run as manual run, i.e. set bit 0 or 1 and the release bit (bit 4) in the control word.
- 3) Wait for the drive moving (bit 6 in the status word is set).
- 4) Wait for the drive has stopped and a positioning error has appeared (bit 6 in the status word is cleared, bit 10 is set).
- 5) Start a manual run in the opposite direction with the same settings (move a certain distance away from the hard stop in order the drive can move freely).
- 6) Only now adjust the desired settings of the above mentioned parameters for normal operation.

5.15. Reverse drive

In vertical positioning with spherical roller spindles, pitches of approx. 4..10 mm and weights from 100 kg, it is possible that the PSx3xx does not consume any energy from the supply when travelling downwards, but rather generates some. This regenerative operation is permissible under certain conditions. The energy generated is fed back into the supply network via the internal regenerative circuit and must be drawn off there. The PSx3xx increases the voltage in the supply network until the additional energy is drawn off. However, the internal protection diode limits this voltage to max. 31 VDC.

The following cases should be considered:

- 1) If several PSx3xx and/or other loads are connected to the same power supply, regeneration is possible without any additional measures if several PSx3xx do not generate power simultaneously. The other devices then act as consumers of the energy generated by a PSx3xx.
- 2) If several PSx3xx are to use the regenerative circuit simultaneously, an overvoltage protection must be provided in the supply network.

If a PSx3xx is operated for more than 1-2 seconds in regenerative mode without consumer of the generated energy, this damages the internal protection diode and the PSx3xx is defective.

5.16. Safe Torque Off

The PSx3xx-STO positioning system is equipped with an emergency stop function (STO – safe torque off). With the STO input, the moment of torque of the electric motor can be switched off.

The following figure illustrates the basic wiring of the PSx3xx-STO:

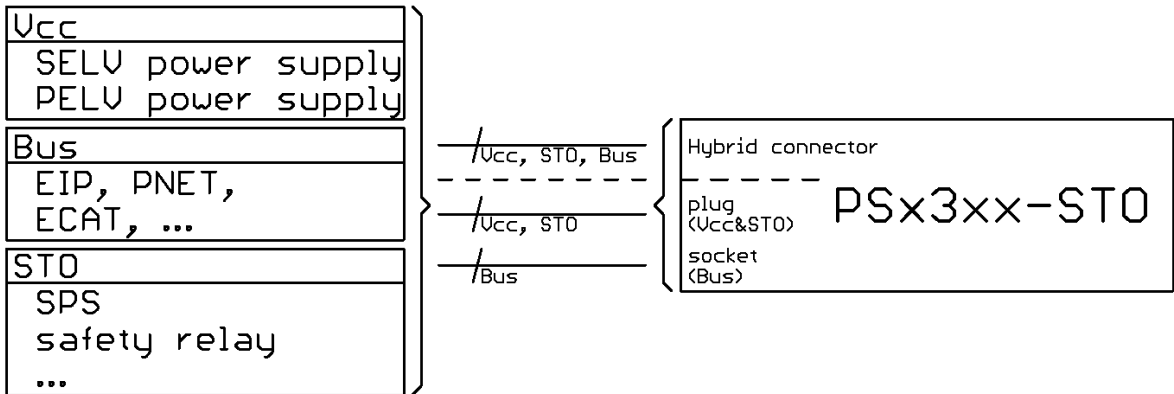

Safe system state:

NOTICE
<p>The positioning system has no movement torque, and no holding torque, which is generated from the commutation of the electric motor. (However there might be a self-locking, resulting from the gear or the optional break) Uncontrolled Shut-down/stop, Stop Category 0, IEC 60204-1 Safe Torque Off, 4.2.3.2 DIN EN 61800-5-2 [4]) The safe system state is quit autonomously when the STO input signal is no longer active.</p> <p>For failures, which are detected from the diagnostic function a quitting of the safe system state is prohibit until a power-down / power-up sequence. This state is signalled to the user by bit 9 in the status word.</p>

NOTICE
<p>An in depth description of the STO functionality, the safety relevant figures, the function and use of the test pulses (OSSD) can be read in the safety manual (Document No. 7100.006654).</p>

6. Technical Data

For additional specifications and dimension drawings, please visit our website at <https://www.halstrup-walcher.de/en/products/drive-technology/>



6.1. Ambient conditions

ambient temperature	0°C to +45°C		
storage temperature	-10°C to +70°C		
shock resistance when installed according to DIN EN 60068-2-27	50 g 11 msec		
resistance to vibration when installed according to DIN EN 60068-2-6	10 Hz to 55 Hz 1.5 mm 55 Hz to 1000 Hz 10 g 10 Hz to 2000 Hz 5 g		
EMC standards (EN IEC 61800-3 und EN 61800-5-2)	CE		
conformity	CE / UKCA NRTL-Certificate: TÜV Süd Product Services GmbH STO-Certificate: TÜV Rheinland Industrie Service GmbH, Certificate No. 01/205/5840.00/21		
protection class	PSE	IP 54 / IP 65	
	PSS	IP 65	
	PSW	IP 66 (in operation) IP 68 (at standstill)	
duty cycle	Device model	Duty cycle in %	Base time in sec.
	PSE30xx...33xx	30	300
	PSS	20	600
	PSW	20	600

6.2. Electrical data

nominal power output	PSx30x, PSx31x, PSE31xx	25 W with 30% duty cycle
	PSx32x, PSx33x	35 W with 30% duty cycle
supply voltage	24 VDC ±10% (supply voltages for motor and control unit are combined)	
Power supplies	use of SELV / PELV power supplies	
Crowbar circuit	A crowbar circuit disconnects the positioning system from the power supply by voltages >30V. Reset by power down	
nominal current, motor (motor and control unit)	PSx30x PSx31x PSE31xx	2.2 A (without break) 2,4 A (with break)
	PSx32x PSx33x	2.9 A (without break) 3,1 A (with break)
input current STO input	< 10 mA	
positioning resolution	0.9°	
positioning accuracy	0.9°	
protocol	EtherNet/IP (IEC 61158-6-2)	
absolute value acquisition	optical - magnetic	

6.3. STO Data

Performance Level (DIN EN ISO 13849)	“c”
Safety Integrity Level (DIN EN 61800)	SIL 1
STO input level	Low <5 V; High >15 V
No STO EVENT (normal operation)	High level with test pulses (OSSD, optional)
STO Event (Emergency-Stop)	Low level

NOTICE

Detailed information about the technical data of the STO functionality can be read into the safety manual.

6.4. Physical data

positioning range	250 usable rotations, no mechanical limits measuring system has a span of 256 turns, minus 3 turns security stock at upper and lower range limit	
torsional rigidity (angle of rotation when switching from operation without backlash to maximum torque)	max. 0.2°	
gear backlash (without spindle compensation run)	max. 0.5°	
spindle lash compensation	automatic loop after every positioning run (may be deactivated)	
output shaft	PSE30x-8 PSE31x-8	8H9 hollow shaft with adjustable collar
	PSE30x-14, PSE31x-14 PSE32x, PSE33x	14H7 hollow shaft with adjustable collar
	PSE31xx	14h7 hollow shaft with clamp and feather key
	PSS3xx-8 PSW3xx-8	8H9 hollow shaft with adjustable collar or 8h8 solid shaft
	PSS3xx-14 PSW3xx-14	14H7 hollow shaft with adjustable collar or 14h8 solid shaft
recommended diameter of the spindle head	according to the hollow shaft diameter with an interference fit of h9	
Vibration emission	not in the harmful range	
Noise emission	not in the harmful range	
maximum radial force	40 N	
maximum axial force	20 N	
dimensions (l x w x h)	see drawings	
weight (approx.)	PSx30x-8	650 g
	PSx30x-14, PSx32x	1200 g
	PSx31x-8	700 g
	PSx31x-14, PSx33x	700 g
	PSE31xx	1200 g

7. Certificate of Conformity



EU-Konformitätserklärung EU Declaration of Conformity

Firma Company	halstrup-walcher GmbH, Stegener Str. 10, 79199 Kirchzarten / Germany		
	erklärt als Hersteller in alleiniger Verantwortung, dass das Produkt declares as manufacturer under sole responsibility, that the product		
Produkt Product	Positionierantriebe Baureihen PSE3xx(x), PSS3xx(x), PSW3xx(x) mit STO (Safe Torque Off) Teilsicherheitsfunktion Positioning Systems Series PSE3xx(x), PSS3xx(x), PSW3xx(x) with STO (Safe Torque Off) Sub Safety Function		
Richtlinien Regulations	den folgenden Europäischen Richtlinien entspricht: conforms to following European Directives:		
	EMV	EMC	2014/30/EU
	RoHS	RoHS	2011/65/EU
	Maschinen	Machinery	2006/42/EG *)
Normen Standards	angewandte harmonisierte Normen: applied harmonized standards:		
	EN IEC 61800-3:2018		
	EN IEC 63000:2018		
	EN 61800-5-1:2007 + A1:2017 *)		
	EN 61800-5-2:2017 *)		
Benannte Stelle Notified Body	TÜV Rheinland Industrie Service GmbH Am Grauen Stein DE 51105 Köln / Germany http://www.tuv.com ☎ +49 221 806-2434	Kennnummer: Registration No.:	0035
EU Baumusterprüfung Zertifikat Nr. EC Type Examination Certificate No.			01/205/5840.00/21

Geschäftsführer



Managing Director

Kirchzarten, 12. Apr. 2021

*) Nur für Baumusterprüfung. Der Anwender muss die Konformität der fertigen Maschine sicherstellen!
For type examination only. The end-user is responsible for ensuring conformity of the completed machinery!

halstrup-walcher GmbH
Stegener Straße 10
79199 Kirchzarten

Telefon: +49 (0) 7661 3963-0
Fax: +49 (0) 7661 3963-99
E-Mail: info@halstrup-walcher.de

Geschäftsführer: Jürgen Walcher, Christian Surs
Handelsregister Freiburg HRB 2209
Umsatzsteuer-ID-Nr. DE 811169901



UK Declaration of Conformity

Company halstrup-walcher GmbH, Stegener Str. 10, 79199 Kirchzarten, Germany
declares as manufacturer under sole responsibility, that the product

Product Positioning System Models PSE3xx / PSS3xx / PSW3xx

Regulations is in conformity with relevant statutory requirements:

EMC Electromagnetic Compatibility Regulations 2016 No. 1091
RoHS RoHS Regulations 2012 No. 3032

Standards applied standards:
EN 55011:2016+A1:2017; EN 61000-6-2:2005; EN 61800-3:2004/ A1:2012
EN IEC 63000:2018

Declaration signed for and on behalf of

Geschäftsführer

Managing Director

Kirchzarten, 26. Jan. 2022

halstrup-walcher GmbH
Stegener Straße 10
79199 Kirchzarten

Telefon: +49 (0) 7661 3963-0
Fax: +49 (0) 7661 3963-99
E-Mail: info@halstrup-walcher.de

Geschäftsführer: Jürgen Walcher, Christian Sura
Handelsregister Amtsgericht Freiburg HRB 2209
Umsatzsteuer-ID-Nr. DE 811169901