



Instruction Manual

PSx3xxSE



halstrup-walcher GmbH

Stegener Straße 10
D-79199 Kirchzarten

Phone: +49 (0) 76 61/39 63-0

E-Mail: info@halstrup-walcher.com
Internet: www.halstrup-walcher.com

Revision overview

Version	Date	Author	Content
G	20.01.22	Sys	
H	08.08.23	Ts	revise manual, new chapter 2.3 powering device, chapter 2.2 detailed description added.
I	10.08.23	Ts	reference mapping extended p.22, new chapter 3.5 upper mapping end, QR code measurement technology, current consumption "Electrical data" corrected. New chapter Limitation of liability and cross-sections Power supply cables. Reference to axial and radial forces in chap. Assembly
J	19.06.24	Ts	Error corrections, safety topics, meaning of the operating instructions revised, intended and non-intended use added, limitation of liability revised, new product labeling, assembly chapter revised, vibration and noise emissions in Physical Data added, Plug colour designation removed

Translation of the original instructions

© **2024**

The manufacturer owns the copyright to this instruction manual. It contains technical data, instructions and drawings detailing the devices' features and how to use them. It must not be copied either wholly or in part or made available to third parties. These operating instruction is part of the product. Read these instructions carefully, follow our instructions and pay particular attention to safety instructions. The instructions should be available at all times.

Purpose of instruction manual

This instruction manual describes the features of the PSx3xx positioning system and provides guidelines for its use.

Every person who is tasked with carrying out work on or with the appliance must have read and understood the operating instructions before starting work on the appliance. This also applies if the person concerned has already worked with such an appliance or a similar appliance or has been trained by the manufacturer.

These appliances can pose a risk to persons and property due to improper use and incorrect operation. For this reason, every person entrusted with handling the appliances must be trained and aware of the dangers. The operating instruction and in particular the safety instruction contained therein must be carefully observed.

Always contact the manufacturer if you do not understand any parts of these instructions.

Handle these operating instructions with care:

- It must be kept within easy reach for the entire service life of the appliances.
- It must be passed on to subsequent personnel.
- Any supplements issued by the manufacturer must be included.

The manufacturer reserves the right to further develop this device type without documenting this in each individual case. Your manufacturer will be happy to provide you with information on the current status of these operating instructions.

Conformity

This device is state of the art.

It complies with the statutory requirements of the EC and UK-directives.

This is documented by the CE and the UKCA mark being affixed.



Accessoires PSx3xx-CA series

We offer you the corresponding supply and data plugs for all unit types. Please contact our sales department, stating the complete type designation, at the following e-mail address

Vertrieb@halstrup-walcher.de

Table von Contents

<i>Revision overview</i>	1
<i>Purpose of instruction manual</i>	3
<i>Conformity</i>	3
1. Safety precautions	6
1.1. Qualified personnel	6
1.2. Explanation of symbols	6
1.3. Appropriate use	7
1.4. Inappropriate use	8
1.5. Limitation of liability	9
1.6. Faults, maintenance, repair, disposal	9
1.7. Product labelling	10
2. Device description	11
2.1. Functions	11
3. Installation	12
3.1. Electrical connection	12
3.2. Assembly of the positioning system	13
3.2.1. Hollow shaft	13
3.2.2. Solid shaft	15
3.3. Disassembly	15
3.4. Powering the device	16
3.5. Pin assignment	16
3.5.1. Supply voltage connector (24VDC)	16
3.5.2. Sockets for the bus (Port 1 and Port 2)	17
3.6. Electrical grounding (Chassis)	17
3.7. Setting the device address	17
3.8. LEDs and address switches	17
3.9. sercosIII cycle data	18
3.9.1. Master to PSx3xxSE (MDT)	18
3.9.2. PSx3xxSE to Master (AT)	19
3.10. Parameters	20
3.10.1. Read only parameters	20
3.10.2. Writable parameters	21
3.10.3. Table of type-dependent values	24
3.10.4. Commands	25
3.11. Error messages	26
3.11.1. Error (C1D)	26
3.11.2. Warnings (C2D)	26
4. Special features	27
4.1. Positioning	27
4.1.1. Positioning sequence with loop	28
4.1.2. Positioning sequence without loop	29
4.2. Speed, acceleration and delay	29
4.3. Response if the drive encounters an obstacle or is turned manually	29
4.4. Use of the "Upper mapping end" parameter	29
4.4.1. Delivery state	29
4.4.2. Shifting the positioning range upwards starting from the delivery state	30
4.4.3. Shifting the positioning range downwards starting from the delivery state	31
4.4.4. Shifting the positioning range depending on the actual position	32
4.4.5. Step-by-step instructions for determining the positioning range	34
4.5. Readjustment	35
4.6. Drag error	35

4.6.1.	Monitoring.....	35
4.6.2.	Correction.....	35
4.7.	Absolute measuring system	36
4.7.1.	Positioning range (S-0-0278).....	36
4.7.2.	Scale for the positional data (S-0-0079 and P-0-0079).....	37
4.7.3.	Direction of rotation (S-0-0055).....	38
4.7.4.	Referencing (S-0-0175) and/or (S-0-0052).....	38
4.7.5.	Setting parameters without automatic adjustment.....	38
5.	<i>Technical data</i>	39
5.1.	Ambient conditions.....	39
5.2.	Electrical data.....	39
5.3.	Physical data.....	40
6.	<i>Certificate of Conformity</i>	41

1. Safety precautions

This section provides an overview of all the important safety aspects for optimum protection of personnel and for safe and trouble-free operation.

1.1. Qualified personnel

These operating instructions are intended for qualified electricians and fitters who are authorized to install, electrically connect, commission and label devices and systems in accordance with safety standards, as well as for the operator and manufacturer of the system on which the drives are installed.

The personnel must be provided with all applicable accident prevention and safety regulations that arise during commissioning or installation of the system.

It must be ensured that the personnel are familiar with all applicable accident prevention and safety regulations.

1.2. Explanation of symbols

In these operating instructions, the following highlights are used to draw attention to the hazards described below when handling the system:

⚠ DANGER	DANGER! Indicates a situation of imminent danger, which will lead to a fatality or serious injuries if not prevented.
⚠ WARNING	WARNING! Indicates a potentially dangerous situation, which may lead to a fatality or serious injuries if not prevented.
⚠ CAUTION	CAUTION! Indicates a potentially dangerous situation, which may lead to minor/slight injuries if not prevented.
NOTICE	NOTICE Indicates a potentially harmful situation, which may lead to material damage if not prevented.

1.3. Appropriate use

Positioning systems are especially suitable for automatically setting tools, stops or spindles for wood-processing equipment, packing lines, printing equipment, filling units and other types of special machines.

PSx3xx positioning systems are not stand-alone devices and may only be used if coupled to another machine.



WARNING

Personal injury and property damage due to incorrect use of the products!

The positioning systems are designed for use in an industrial environment and may only be used as intended. If they are not used as intended, situations may arise that result in damage to property and personal injury.

NOTICE

The device is used as intended if all instructions and information in these operating instructions are observed.

- Only operate the device in perfect technical condition
- When attaching to a machine, observe the current safety regulations.
- Do not operate the product in all installed state unless all necessary protective measures have been taken.
- Observe the relevant regulations for the prevention of accidents (e.g. accident prevention regulations).
- In order to avoid the risk of accidents due to contact with moving parts, appropriate separating or non-separating guards must be provided.
- Use appropriate protective equipment (e.g. safety helmet, safety goggles, safety shoes, protective gloves).
- Use appropriate assembly and transport equipment.
- Store and transport the product in its original packaging, reuse protective caps for plugs if necessary.
- Adequate ventilation must be provided at the point of use to avoid excessive heating.
- During project planning, ensure that the device is always operated within its specifications. See technical data in chapter 5. Technical data.
- If the device is equipped with a brake, it is not a safety brake that may be used for safety functions.
- In special areas of application such as the chemical, pharmaceutical or food sector, the positioning system in stainless steel design is possible.

1.4. Inappropriate use

The use of the positioning devices outside of the operating conditions and technical data and specifications described in the documentation is considered “improper”. The drives are designed for intended operation under normal ambient conditions (according to EN / IEC / UL 61010-1), with the exception of an extended temperature range.

- Operation inside buildings
- Operation at altitudes up to 2000m above sea level
- Ambient temperatures deviating from standard: 0°C to 45°C
- Maximum relative humidity 80% at temperatures up to 31°C, decreasing linearly to 50% relative humidity at 45°C
- Fluctuations in the supply voltage up to $\pm 10\%$ of the nominal voltage at 50% relative humidity at 45°C
- The IP-protection rating is a manufacturer specification.

Any use of the device that goes beyond the intended use and/or is used differently can lead to dangerous situations

- Underwater usage of the PSW is not allowed
- The positioning system cannot be used for certain applications, such as the transport of people and animals or as a press-bending device for cold processing of metal.
- If the operation requirements stated in chapter 5. Technical data are exceeded, personal injury or property damage may occur.
- The positioning system cannot be used in hazardous areas.
- The holding brake must not be used to brake the motor.
- Under no circumstances may the housing cover be used for power transmission purposes, e.g. for supporting, climbing or similar.

1.5. Limitation of liability

The device may only be operated in accordance with these operating instructions. All information and instructions in these operating instructions have been compiled taking into account the applicable standards and regulations, the state of the art and our many years of experience and knowledge.

The manufacturer accepts no liability arising from improper or unintended use.

Warranty claims also expire in this case:

- non-observance of the operating instructions
- improper use
- improper installation
- improper use
- Use by untrained personnel
- Modifications to the device
- Technical modifications
- Unauthorized modifications

The user is responsible for carrying out commissioning in accordance with the safety regulations of the applicable standards and all other relevant national or local regulations regarding conductor dimensioning and protection, grounding, circuit breakers, overcurrent protection, etc. The person who carried out the assembly or installation is liable for any damage caused during assembly or connection.

1.6. Faults, maintenance, repair, disposal

Faults or damage to the appliance must be reported immediately to the specialist personnel responsible for the electrical connection.









The appliance must be taken out of operation by the responsible specialist personnel until the fault has been rectified and secured against accidental use.

The appliance requires no maintenance.

Repair work that requires the housing to be opened may only be carried out by the manufacturer.

The electronic components of the appliance contain environmentally harmful substances and are also recyclable materials. The device must therefore be recycled after its final decommissioning. The environmental guidelines of the respective country must be observed.

1.7. Product labelling

Warning symbol	Meaning
	<p>Reference to further documentation Read the operating instructions and safety instructions before transportation, installation or commissioning</p>
	<p>Warning of hot surface The appliance can become very hot during operation. Temperatures of over 70°C can occur. In the event of a fault, internal components may be overloaded. Use personal protective equipment or wait long enough for the appliance to cool down.</p>
	<p>Warning of dangerous electrical voltage Before working on the product, check that all power connections are de-energized!</p>
	<p>Disposal of batteries, electrical and electronic equipment</p> <ul style="list-style-type: none"> • In accordance with international regulations, batteries, rechargeable batteries and electrical and electronic equipment must not be disposed of with household waste. • The owner is legally obliged to dispose of these devices properly at the end of their service life. • WEEE: This symbol on the product, its packaging or in this document indicates that a product is subject to these regulations.
	<p>CE marking CE stands for "Conformité Européenne". The CE marking expresses the conformity of a product with the relevant EC directives.</p>
	<p>UKCA marking UKCA stands for "UK Conformity Assessed". The UKCA marking expresses the conformity of a product with all applicable legal requirements of the United Kingdom.</p>
	<p>Safe torque off Corresponds to stop category 0 in accordance with EN 60204-1. The power supply to the drive is interrupted immediately and the drive is brought to an uncontrolled standstill</p>
	<p>GROUNDING Chassis grounding (description in chapter 4.8 Electrical grounding (Chassis)Electrical grounding (Chassis))</p>

2. Device description

2.1. Functions

The PSx3xxSE positioning system, an intelligent, compact, complete solution for positioning auxiliary and positioning axes, consists of an EC motor, gear power amplifier, control electronics, absolute measuring system and sercos 3 interface. The integrated absolute measuring system eliminates the need for a time-consuming reference run. Connecting to a bus system simplifies the wiring. A hollow shaft with adjustable collar makes assembly quite simple. The positioning system is especially suitable for automatically setting tools, stops or spindles for wood-processing equipment, packing lines, printing equipment, filling units and other types of special machines.

PSx3xxSE positioning systems convert a digital positioning signal into an angle of rotation.

3. Installation

3.1. Electrical connection

NOTICE

The following notes on the power supply should be observed.

Minimum cross-sections are required for connection to the power supply. For power cables mounted on the device, use only the cross-sections listed below. In order to minimize voltage drop on longer cables, we always recommend using the largest available cross-section.

Device	Cable cross-section
PSEx31 / PSx32 / PSx33	min. AWG20 or 0,5 mm ²
PSEx34	min. AWG18 or 1,0 mm ²
Fieldbus connections	min. AWG23 or 0,25 mm ²

If there are concerns about mechanical strength or where cables may be exposed to mechanical damage/stress, they must be protected accordingly. This can be ensured, for example, by a cable duct or a suitable armoured pipe.

If the power supply cables are laid in the immediate vicinity of the drives or other heat sources, make sure that the cables have a temperature resistance of at least 90°C. With suitable design measures, e.g. sufficient ventilation or cooling, lower temperatures are also permissible. This must be checked and determined by the customer.

Make sure that the flammability class of the cable for the USA is equivalent to UL 2556 VW-1, e.g. according to IEC 60332-1-2 or IEC 60332-2-2 depending on the cross-section. For Canada, the flammability class FT1 is required, FT4 exceeds this and is therefore also permissible. Cables for the North American market often meet both requirements.

However, the flammability class requirements only apply if you do not limit to Class 2 (e.g. certified power supply) or to <150 W according to UL 61010-1

→ 4.6 Powering the device by means of a suitable fuse.

When installing in North America, please observe the specifications in the National Electrical Code NFPA 70 and the Electrical Standard for Industrial Machinery NFPA 79 (USA) or the Canadian Electrical Code and C22.2 (Canada) in the respective valid version.

3.2. Assembly of the positioning system

CAUTION

The maximum permissible axial and radial forces (see chapter 6.3 Mechanical data) on the motor shaft must not be exceeded during transportation, installation or operation.

CAUTION

Take the weight of the device into account when selecting the fastening screws! Tightening torques of the fixing screws according to the screw manufacturer's specifications!

WARNING

Rotating and/or linearly moving components can cause serious injuries. If there is a risk of accidents during installation or operation, the moving parts must be fitted with guards or protective devices.

NOTICE

Temperature overload

The PSx3xx positioning unit has a simple temperature measuring device to prevent thermal overload. If the temperature in the device exceeds the limit temperature set in the parameterization, this bit is set and repositioning is only possible after the device has cooled down ('Temperature exceeded' bit reset).

3.2.1. Hollow shaft

The PSx3xxSE is mounted on the machine by sliding it with the hollow shaft onto the spindle to be driven and fixing it with the clamping ring (recommended shaft diameter 8 h9 or 14 h9; tightening torque of the clamping ring screw with 3 mm hexagon socket: 1.5 Nm).

CAUTION

The depth of the hollow bore is 20 mm. For optimum operation, the pin of the shaft to be driven should correspond to this depth. Depending on the operating situation, significantly shorter pins (< 16 mm) may cause damage to the PSx3xx. When mounting the PSx3xx, it should only be pushed on until the foam rubber plate lies evenly on the bottom of the machine or is compressed to approx. half its thickness. Under no circumstances may the PSx3xx "hard" be screwed to the machine without an air gap.

The rotation lock is made via the pin (in the picture below the hollow shaft) into a suitable bore as rotary torque support. This hole must be slightly larger than the diameter 6 h9 of the pin.

An oblong hole or slot with a slightly larger width (recommended: 6.05...6.10 mm) than the dimension of the pin diameter is optimal. The backlash when changing the direction of rotation has a direct influence on the positioning accuracy and can lead to damage to the PSx3xx with very large backlash (a few mm) due to the impact load.

**CAUTION**

The PSx3xx must have a little gap on all sides when mounted, as it can move axially and/or radially during positioning if the hollow shaft and solid shaft are not 100% aligned. This "staggering" is not a defect of the PSx3xx and also has no influence on the function, as long as it can move freely. Please note the maximum permissible radial force and axial force in chapter →5.3 Physical data.

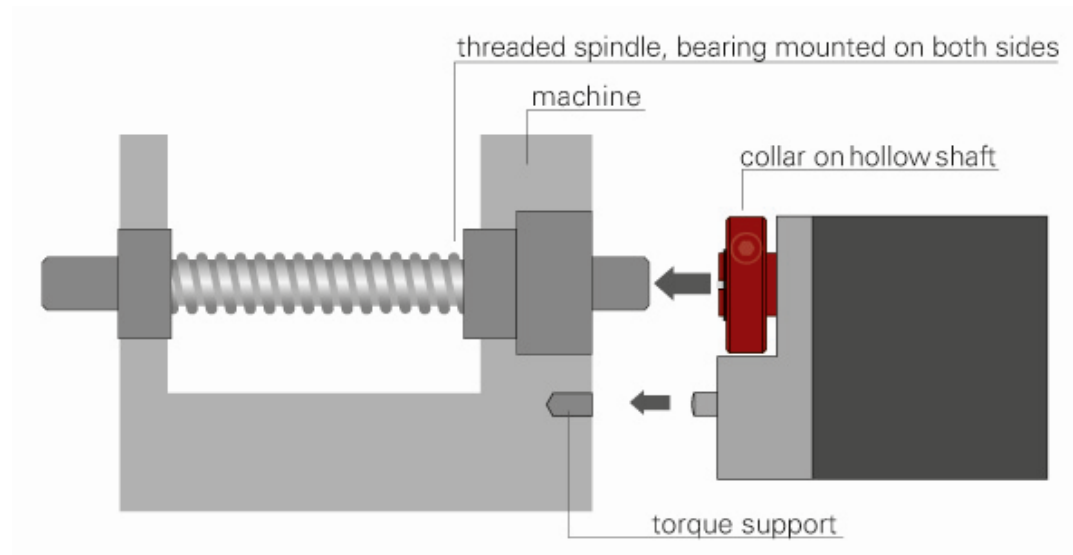

Versions with higher torques (from 10 Nm):

Here the force connection is made via a feather key DIN 6885-A5x5x12.

The clamping ring is not freely rotatable but consists of two halves, the fixed part of the hollow shaft and the loose clamping clamp. The keyway is located in the half that is fixed to the output shaft. When sliding onto the shaft to be driven with the key inserted, its angular position must be aligned with the keyway in the PSx3xx. After pushing on, the PSx3xx is fixed with the 2 screws in the flexible clamping ring half. Make sure that both screws are tightened as equally as possible (tightening torque of the screws with 3 mm hexagon socket: 1.5 Nm).

The information on torque support applies in the same way as described above.

For PSE30x-14, PSE32x-14, PSS30x-14 and PSS32x-14, the position of the anti-rotation lock can be set at greater distances by unscrewing the base cover, turning it 180° and then screwing it back on. When screwing on, make sure that the seal is correctly inserted in the floor.

For torques > 5 Nm we recommend to choose the greater distance.

3.2.2. Solid shaft

The PSx3xxSE is installed on the machine by mounting the drive to the axis to be driven using a coupling and an intermediate flange.

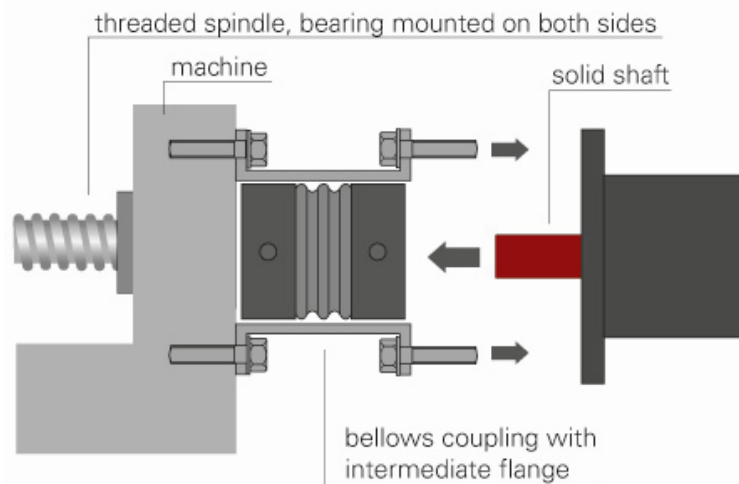

CAUTION

Under no circumstances may the housing cover be used for the purpose of the transmission of force.

CAUTION

Never apply force to the housing cover, e.g., for supporting weight.

CAUTION

Driving the PSx3xx rearward is prohibited (e.g. it's not allowed to turn the output shaft by an external force).

3.3. Disassembly

To remove the PSx3xx from the shaft, release the clamp (for versions with hollow shaft the clamping ring) and pull the PSx3xx off the shaft. If possible, the PSx3xx should only be pulled axially. Excessive bending back and forth can damage the output shaft!

3.4. Powering the device

⚠ CAUTION

For motor power use a single fuse with max. 3,5 A for each PSx3xx.
 For motor power use a single fuse with max. 10 A for each PSE34xx.
 For control power you can use a fuse with max. 2,0 A, so it is possible to power up to 10 units parallel with one fuse.
 It is strongly recommended to separate power cables to the PSx3xx from other power cables that might have dangerous voltage.

⚠ CAUTION

Underwater usage of the PSW is not allowed.



⚠ CAUTION

 Please consider that the device might have a hot surface during operation!

3.5. Pin assignment

For the supply voltage either a Binder series 713/763 (A-coded) round, 5-pin plug for PSE and PSS devices or a 5-pin Harting plug with protective sleeve (HAN4A) for the PSE34xx devices is located in the housing cover of the PSx3xxSE.
 Two round 4-pin sockets, Binder series 825 (D-coded) are provided for connection to the bus.

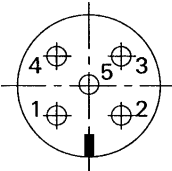
3.5.1. Supply voltage connector (24VDC)

connector pattern (external top view)	assignment	type
	1. +24V motor 2. GND motor 3. +24V control unit 4. GND control unit 5. housing/pressure balance	PSE/PSS: M12 (A-cod.); 5-pol. PSW: M12 (A-cod.); 4-pol. with airtube
	1. +24V motor 2. GND motor 3. +24V control unit 4. GND control unit 5. housing/pressure balance	PSE34xx: HAN4A, Harting

NOTICE

To prevent the ingress of fluids into the PSW-housing during cooldown, use a special cable with an airtube for pressure balancing of your PSW.

3.5.2. Sockets for the bus (Port 1 and Port 2)

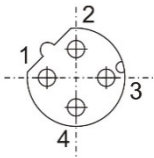
connector pattern (external top view)	assignment	type
	1. TD+ 2. RD+ 3. TD- 4. RD-	M12 (D-cod.); 4-pol.

NOTICE

Due to the use of 5-pin sockets, only five-wire cables should be used.

3.6. Electrical grounding (Chassis)

Next to the connecting plugs there is a M4 stud bolt. It is recommended to connect the positioning system with a cable as short as possible to the machine base. The minimum wire cross section therefor is 1.5mm².

3.7. Setting the device address

In its delivery state, the PSx3xxSE has the address 1. A different address can be assigned using the parameter S-0-1040 or via the optional address switches. If the switches are resting in the position 00 or not available, the address is set using S-0-1040. The change in address is saved automatically and therefore continues to be available after the device is restarted.

If you set the address using the switches (i.e. switches set to > 00) you cannot change this value using the bus.

3.8. LEDs and address switches

The following LEDs are located under the transparent sealing plug:

P1/P2: Green link LEDs for ports 1 and 2

S: sercos LED (see sercosIII specifications)

V-Motor: The LED is illuminated yellow when power is available to the motor.

OFF → Motor power supply is too high or low

ON → Motor power supply ok

flashing → Motor power supply ok, PSx in delivery state

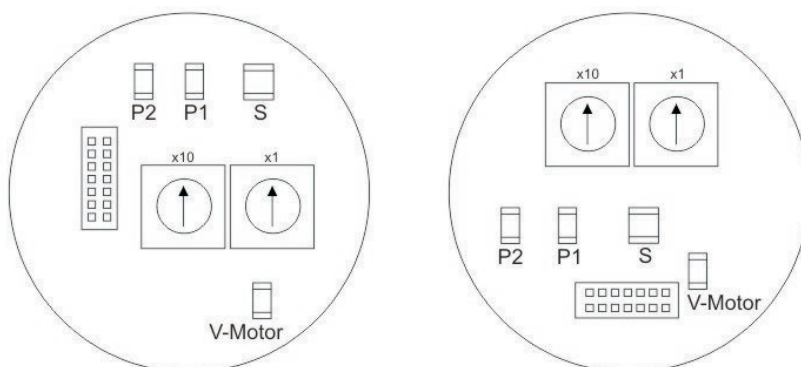

Address switch:

The rotary switches indicate the tens and ones places of the address selected. If the switches are resting in the position 00 or are not available, the address is set using S-0-1040.

The delivery setting is 00, the PSE reports to the bus with the address 1.

If you set the address using the switches (i.e. switches set to > 00) you cannot change this value using the bus.

3.9. sercosIII cycle data

The IO-profile is used with a fixed configuration (SCP_FixCFG). When configuring the connections, you must be aware of the following:

S-0-1050.0.x are the settings for the AT (producer)

S-0-1050.1.x are the settings for the MDT (consumer)

The command and/or status bytes 'Connection Control', 'Positioning Control' and 'Producer RTB word container' are initialised with 0 during the change from CP3 to CP4.

3.9.1. Master to PSx3xxSE (MDT)

Bit	Byte	Meaning	Corresponding IDN
0-15	0-1	Connection control	S-0-1050.1.08
16-31	2-3	I/O Control	S-0-1500.00.01
32-47	4-5	Positioning control	S-0-0346
48-79	6-9	Positioning command value	S-0-0282

Connection Control

Bit 15-12: Counter

Bit 1: New Data

Bit 0: Producer ready

A run command will only accepted if this bit is set.

I/O Control

Bit15: Output operation state

A run command will only accepted if this bit is set.

Positioning control (control word)

Bit 2-1: Positioning modes

00: Positioning → Drive moves to the transferred target value

01: Jogging + → Drive moves to the upper limit switch

10: Jogging - → Drive moves to the lower limit switch

11: Positioning Halt → Drive brakes with the specified deceleration ramp
(can also be used in jogging mode)

Bit 0: Toggle

Must be toggled if a run command is to be accepted.

3.9.2. PSx3xxSE to Master (AT)

Bit	Byte	Meaning	Corresponding IDN
0-15	0-1	Connection control	S-0-1050.0.08
16-31	2-3	I/O status	S-0-1500.00.02
32-47	4-5	Producer RTB word container	S-0-0144
48-63	6-7	Torque feedback value	S-0-0084
64-95	8-11	Velocity feedback value 1	S-0-0040
96-127	12-15	Position feedback value 1	S-0-0051

Connection Control

Bit 15-12: Counter
 Bit 1: New data
 Bit 0: Producer ready

I/O status

Bit 15: Outputs ready to operate
 is set as soon as bit 15 is set in the I/O control

Bit 14: Inputs valid always 1

Bit 13: Error of resource I/O (C1D)
 Error code is in S-0-0390 and diagnosis text in S-0-0095

Bit 12: Warning of resource I/O (C2D)
 Error code is in S-0-0390 and diagnosis text in S-0-0095
 Producer RTB word container (status word)

Bit 3: Positioning halt
 Drive was stopped (by 'positioning halt' command in the control word)

Bit 2: In position (S-0-0336, bit 0)
 Drive is within the positioning window

Bit 1: Status command value processing (S-0-0135, bit 3)
 Drive is running

Bit 0: Takeover positioning command value (S-0-0419, bit 0)
 Accept target value (is toggled)

3.10. Parameters

3.10.1. Read only parameters

Name, designation	IDN	Function	Unit	Byte count/ data type
Actual rpm	S-0-0040	Current rpm	1/min	4 / signed decimal
Actual position	S-0-0051	Current position	*	4 / signed decimal
Actual torque	S-0-0084	Current torque value	cNm	2 / signed decimal
In position	S-0-0336	Drive is in the positioning window	-	2 / binary
Motor supply voltage	S-0-0380	Current supply voltage for the motor	V	2 / unsigned decimal
Temperature	S-0-383	Internal temperature of the device	°C	2 / unsigned decimal
Error text	S-0-0095	Error in text form	-	Full text
Diagnosis code	S-0-0390	Code for errors and/or warnings (see Section 4.13 Error messages)	-	4 / hexadecimal
Vendor code	S-0-1300.0.3	sercosIII Vendor code (10)	-	2 / unsigned decimal
Device type	S-0-1300.0.5	PSE3xx-xx bzw. PSE3xxVG-xx	-	Full text
Software version	S-0-1300.0.9	x.xx	-	Full text
Serial number	S-0-1300.0.12	Device serial number	-	Full text
Production date	S-0-1300.0.13	YYYY-MM-DDTHH:MM:SSZ	-	Full text
Maximum torque	P-0-0084	Maximum torque value during the last run, not valid in the acceleration and deceleration phase	cNm	2 / signed decimal
Control unit voltage	P-0-0380	Current supply voltage for control unit	V	2 / unsigned decimal

* The units are dependent on the scale (S-0-0079 and P-0-0079).

3.10.2. Writable parameters

Name, designation	IDN	Function	Byte / Type
Upper limit	S-0-0049	Maximum permitted target position Unit: * Min.: lower limit Max.: positioning range – 3 rotations Default setting: 101200 Changes only possible when at a standstill	4 / sd
Lower limit	S-0-0050	Minimum permissible target position Unit: * Min.: positioning range – 253 rotations Max.: upper limit Default setting: 1200 Changes only possible when at a standstill	4 / sd
Referencing of the position	S-0-0052	Writing causes the current position to be "referenced" onto the transferred value The limit switch and the positioning range are also shifted. The difference is found in S-0-0175. Unit: * Min./Max.: Any desired value Default setting: 0 Changes only possible when at a standstill	4 / sd
Direction of rotation	S-0-0055	When looking at the output shaft: 16: clockwise 23: counter clockwise Default setting: 16 Changes only possible when at a standstill	2 / bin
Positioning window	S-0-0057	Permissible difference between target and actual values for the "in position" bit (S-0-0336) Unit: * Min.: 1* Max.: 100* Default setting: 2 Changes only possible when at a standstill	4 / ud
Loop length	S-0-0058	Number of increments, which the drive runs to a target in a specified direction. Run without loop with value 0 Unit: * Min.: -400* Max.: 400* Default setting: -250 Changes only possible when at a standstill	4 / sd
Scale for positional data	S-0-0079	Increments per revolution, e.g. spindle pitch 1.5 mm with resolution 1/100 mm → 150 Min.: 1 Max.: 10000 Default setting: 400 Changes only possible when at a standstill	4 / ud
Maximum torque	S-0-0092	Max. permissible torque during the run Unit: cNm Default setting: **	2 / ud

Name, designation	IDN	Function	Byte / Type
Drag error	S-0-0159	Max. drag error before a C2D warning is generated Monitoring deactivated with 0. Unit: * Min.: 0 Max.: 1000* Default setting: 0	4 / ud
Reference value	S-0-0175	Correction factor for the target, actual and limit switch values Unit: * Min./Max.: Any desired value Default setting: 0 Changes only possible when at a standstill	4 / sd
Target rpm	S-0-0259	Rpm to be used for positioning runs Unit: 1/min Min./Max.: ** Default setting: **	4 / sd
Acceleration	S-0-0260	Acceleration ramp Unit: rotations/(min * sec) Min./Max.: ** Default setting: **	4 / sd
Positioning range	S-0-0278	Definition of the positioning range relative to the absolute value encoder Unit: * Min.: actual position + 3 rotations Max.: actual position + 253 rotations Default setting: 102400 Changes only possible when at a standstill	4 / sd
Target value	S-0-0282	Specified target position (can be written using SVC in CP2-4), stop by writing the same target value once again Unit: *	4 / sd
Deceleration	S-0-0359	Deceleration ramp Unit: rotations/(min * sec) Min./Max.: ** Default setting: **	4 / sd
Holding torque	S-0-0533	Holding torque at standstill Unit: cNm Min.: 0 Max.: ** Default setting: **	4 / sd
Maximum start-up torque	S-0-0822	Max. permissible torque in the start-up phase Unit: cNm Min./Max.: ** Default setting: **	2 / ud
Time for start-up torque	S-0-0823	Time in which the start-up torque applies Unit: msec Min.: 10 Max.: 1000 Default setting: 200	2 / ud

Name, designation	IDN	Function	Byte / Type
Address	S-0-1040	sercosIII address Min.: 1 Max.: 511 Default setting: 1	2 / ud
Extended scale for positional data	P-0-0079	Used in combination with S-0-0079 to set "unlevel" resolutions Min.: 1 Max.: 10000 Default setting: 400 Changes only possible when at a standstill	4 / ud
Drag error correction factor	P-0-0159	Drag error correction is deactivated with the value 0. Min.: 0 Max.: 10 Default setting: 0 Changes only possible when at a standstill	2 / ud
Holding torque at completion of run	P-0-0822	Holding torque at completion of run Unit: cNm Min.: 0 Max.: ** Default setting: **	2 / ud
Time for holding torque at completion of run	P-0-0823	Time for holding torque at completion of run Unit: cNm Min.: 0 Max.: ** Default setting: **	2 / ud
Adjustment release	P-0-0900	Adjustment with value = 1 (only for PSE without brake) Min.: 0 Max.: 1 Default setting: 0	2 / ud

- * The units and/or values are dependent on the scale (S-0-0079 and P-0-0079).
- ** The value depends on the type of device (see following table).

3.10.3. Table of type-dependent values

Device type	301-x	302-x	305-x	322-14	325-14
PSE and PSS	311-x	312-x	315-8	332-14	335-14
Name, designation	Range of values				
IDN	Delivery state				
Max. torque S-0-0092	2..125 100	10..250 200	50..600 500	10..250 200	20..500 400
Target rpm S-0-0259	15..230 230	10..150 150	3..70 70	20..200 170	10..100 85
Acceleration S-0-0260	97..600 600	50..400 400	23..130 130	97..525 525	50..260 260
Delay S-0-0359	97..600 600	50..400 400	23..130 130	97..525 525	50..260 260
Holding torque S-0-0533	0..90 30	0..150 50	0..300 100	0..100 35	0..200 70
Start-up torque S-0-0822	2..125 125	10..250 250	50..600 600	10..250 250	20..500 500
Holding torque at completion of run P-0-0822	0..180 60	0..300 100	0..600 200	0..200 70	0..400 140

PSE and PSS	311-x	312-x	315-8	328-14	332-14	335-14	335-14
Name, designation	Range of values						
IDN		Delivery state					
Max. torque S-0-0092	2..125 100	10..250 200	50..600 500	80..960 800	10..250 200	20..500 400	20..500 400
Target rpm S-0-0259	15..230 230	10..150 150	3..70 70	5..45 45	20..200 170	10..100 85	10..100 85
Acceleration S-0-0260	97..600 600	50..400 400	23..130 130	22..100 100	97..525 525	50..260 260	50..260 260
Delay S-0-0359	97..600 600	50..400 400	23..130 130	22..100 100	97..525 525	50..260 260	50..260 260
Holding torque S-0-0533	0..90 30	0..150 50	0..300 100	0..450 150	0..100 35	0..200 70	0..200 70
Start-up torque S-0-0822	2..125 125	10..250 250	50..600 600	80..960 960	10..250 250	20..500 500	20..500 500
Holding torque at completion of run P-0-0822	0..180 60	0..300 100	0..600 200	0..700 300	0..200 70	0..400 140	0..400 140

Device type PSW	301-x 311-x	302-x 312-x	305-x 315-8	328-14	322-14 332-14	325-14 335-14
Name, designation IDN	Range of values Delivery state					
Max. torque S-0-0092	2..125 100	10..250 200	50..600 500	80...960 800	10..250 200	20..500 400
Target rpm S-0-0259	15..180 180	10..125 125	3..60 60	5...35 35	20..150 125	10..80 60
Acceleration S-0-0260	97..600 600	50..400 400	23..130 130	22...100 100	97..525 525	50..260 260
Delay S-0-0359	97..600 600	50..400 400	23..130 130	22...100 100	97..525 525	50..260 260
Holding torque S-0-0533	0..90 30	0..150 50	0...300 100	0...450 150	0..100 35	0..200 70
Start-up torque S-0-0822	2..125 125	10..250 250	50..600 600	80...960 960	10..250 250	20..500 500
Holding torque at completion of run P-0-0822	0..180 60	0..300 100	0..600 200	0...700 300	0..200 70	0..400 140

Device type PSE	3110-14	3125-14	3410-14	3418-14
Name, designation IDN	Range of values Delivery state			
Max. torque S-0-0092	100..1200 1000	250..3000 2500	200..1200 1000	500..2000 1800
Target rpm S-0-0259	1..30 30	1..12 12	10..100 100	10..90 90
Acceleration S-0-0260	9..50 50	4..20 20	20..350 350	10..315 315
Delay S-0-0359	9..50 50	4..20 20	20..350 350	10..315 315
Holding torque S-0-0533	0..600 200	0..1250 450	0..300 200	0..450 300
Start-up torque S-0-0822	100..1200 1200	250..3000 3000	200..1200 1200	500..2000 2000
Holding torque at completion of run P-0-0822	0..1200 400	0..2500 900	0..600 400	0..900 600

3.10.4. Commands

Name, designation	IDN	Function
Delete error	S-0-0099	Deletes the C1D error
Load default settings	S-0-0262	The default settings are loaded. In order to save these permanently, you must subsequently execute S-0-0264
Save settings	S-0-0264	Saves the parameter in EEPROM

3.11. Error messages

Errors (C1D) and warnings (C2D) are reported using bits 13 and 12 in the I/O status. The diagnosis code is stored in S-0-0390 and the diagnosis text in S-0-0095.

3.11.1. Error (C1D)

The sercos LED is illuminated red when an error occurs.

When an error occurs during the run, the run is aborted. No further run commands will be accepted until the error is deleted. Errors are deleted using IDN S-0-0099. If the error continues, the error message will be displayed again.

The type of error can be found in the diagnosis code (S-0-0390).

0xC00F2019:	Internal device temperature exceeds specified limit.
0xC00F2026:	Motor voltage too low (voltage < 17.5V).
0xC00F2055:	Obstruction (extreme difficulty running, insufficient torque).
0xC00F8022:	Error in calculating/determining the absolute position. This error cannot be deleted. If necessary, restart drive.
0xC00F8025:	Motor voltage too high (voltage > 30V).
0xC00F8028:	Motor current too high.
0xC10F6320:	Incorrect parameters (error in loading or saving). This error cannot be deleted. Restart the drive and, if the error continues, load the default settings with S-0-0262.

3.11.2. Warnings (C2D)

A warning does not result in a run being aborted. Run commands continue to be accepted when warnings are active. The drive issues the following warnings (S-0-0390):

0xC00E2028:	Drag error (see Section 5.10 Response if the drive encounters an obstacle or is turned manually) A new run command deletes this warning.
0xC00E2053:	Invalid target value, target value lies outside the permissible positioning range. A new run command deletes this warning.
0xC00E6043:	Upper limit exceeded. Warning is deleted as soon as the drive is within the permissible positioning range.
0xC00E6044:	Lower limit exceeded. Warning is deleted as soon as the drive is within the permissible positioning range.

4. Special features

4.1. Positioning

To perform a positioning run, the control word (positioning control) must be written as follows in the MDT: bit 2-1 = 00 and bit 0 must be toggled. When the run command has been successfully accepted, the bit 0 in the status word (Producer RTB word container) is toggled in the AT.

Here are the responses in various situations:

New target value during a run

The new target position is accepted immediately. If a change of direction is required, the drive brakes using the set deceleration ramp and then approaches the new target value.

Stop command

To perform a stop command, the control word (positioning control) is written as follows in the MDT: bit 2-1 = 11 and bit 0 must be toggled.

Stop command during a run:

- The drive brakes using the maximum possible deceleration ramp.
- There will be no readjustment of the position (see also readjustment P-0-0900).
- Bit 3 (positioning halt) in the status word (Producer RTB word container) will be set.

Stop command during standstill:

- Bit 2 (in position) in the status word (Producer RTB word container) will be set to 0.
- There will be no readjustment of the position (see also readjustment P-0-0900).



CAUTION

Toggling bit 0 of the control word (positioning control) in the MDT leads to the generation of a run command in the drive even if the drive is already at the target value because the internal resolution is higher. Constant toggling of bit 0 must therefore be avoided.



CAUTION

Runs, which involve a run to an obstruction (e.g. reference runs to a block), may only be started with reduced torque (max. run torque < 10% of nominal torque).

4.1.1. Positioning sequence with loop

By default, the PSx3xx always approaches each setpoint from the same direction. If a destination is in the opposite direction to the loop direction, the setpoint is first traversed by the value of the loop length (S-0-0058) and then finally approached. This can, for example, eliminate the backlash of a driven spindle.

The PSx3xx thus distinguishes the following cases during a positioning process:
Assumption: Each target position is approached in forward direction, i.e. the loop length is $-250 = 5/8$ revolutions.

1. New setpoint position is greater than the current actual position: The target is approached directly.

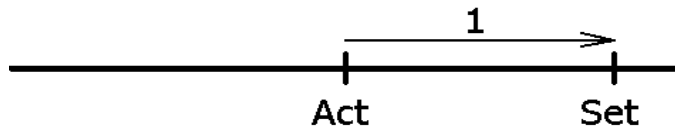

2. New setpoint position is smaller than the current actual position: The device is moved further back by the loop length (2a) and the final destination is then approached in forward motion (2b).

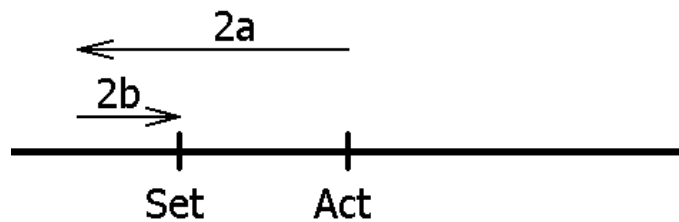

3. New setpoint position is only slightly larger than the current actual position and previously there was no positioning movement with loop (e.g. a manual movement):

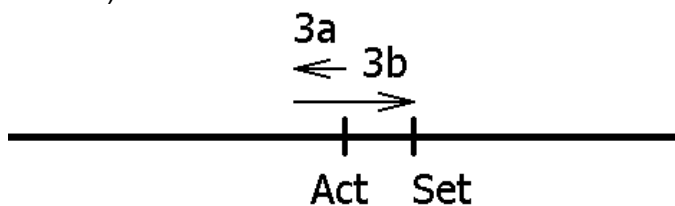

In all cases, the drive approaches the target with a forward movement whose length corresponds at least to the loop length. In order to achieve this, the drive first moves in reverse direction (3a), i.e. against the actually desired direction of travel, and then forwards the actual destination (3b).

The maximum length of this distance is the loop length. If the setpoint differs from the current actual value by more than the loop length, it is approached directly.

After reaching the target position, this position is compared with the internal absolute encoder status. If there is a deviation, the status bit "Error" is set (bit 9 in the status word).

In the delivery state, the loop length is -250 steps, i.e. each setpoint position is approached in the forward direction.

NOTICE

A positioning to the upper end limit (S-0-0049) with a loop length > 0 is not possible, since the drive would have to cross the end limit for this. The same applies to the lower end limit (S-0-0050) with a loop length < 0.

4.1.2. Positioning sequence without loop

Positioning runs from both directions are possible without a loop if the loop length (S-0-0058) is set to 0. This does NOT eliminate any lash present in the spindle. The PSx3xxSE internal gear backlash does not play a role in this case, as position data are acquired directly at the output shaft.

4.2. Speed, acceleration and delay

The target speed from S-0-0259, acceleration from S-0-0260 and delay from S-0-0359 apply for all runs. As the drive approaches the target at the end of the run, the delay is successively reduced in order to ensure a harmonious transient response. If a stop command is executed, the drive brakes with the maximum possible deceleration ramp.

4.3. Response if the drive encounters an obstacle or is turned manually

If during a run the achievable rate of speed falls below the threshold parameter (30% of the target speed) for longer than 200 ms, the instrument registers an obstacle, aborts the run and a C1D error message is generated (diagnosis code: 0xC00F2055). The drive then stands still with the set holding torque (S-0-0533). A new run command will only be accepted when the error has been deleted (see 4.11.2 PSx3xxSE to Master (AT)).

If, when the drive is at a standstill, it is pushed out of the positioning window, the bit 'In Position' (see Section 4.13 Error messages) will be deleted. If readjustment is active (S-0-0900), the drive will return to the target value.

**CAUTION**

The drive must not be turned into another position with an electric screwdriver.

4.4. Use of the “Upper mapping end” parameter

The following chapter illustrates the use of the parameter “upper mapping end” both graphically and by means of examples:

4.4.1. Delivery state

In the delivery state (“DS”), the actual position is exactly in the middle of the positioning range. There is a safety margin of three rotations at the output shaft at both the lower and upper ends of the positioning range. Positioning runs that extend into these safety margins are rejected by the device with the error “Incorrect target value”.

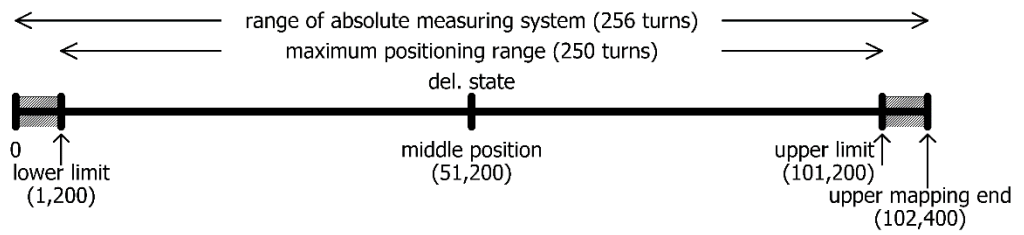

In the delivery state, the values from the following table result for the upper mapping end and the lower and upper limits:

Upper mapping end	102,400
Lower limit	1,200
Upper limit	101,200

Positioning range symmetrical to 51,200

Starting from this state, the maximum possible positioning range can now be shifted upwards or downwards as required.

It is important to note that after the device has been installed, the available positioning range may not be sufficient in one of the two directions. The parameter "upper mapping end" now allows you to reduce the positioning range in one direction and increase it in the other direction.

4.4.2. Shifting the positioning range upwards starting from the delivery state

In the following example, starting from the DS, the maximum possible positioning range is shifted slightly upwards using the parameter "upper mapping end":

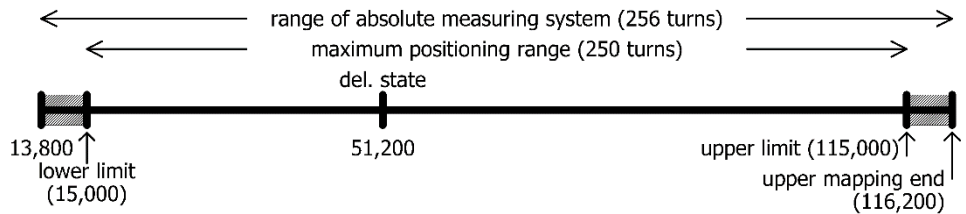

Here, the upper mapping end was increased from the value 102,400 to 116,200. Consequently, a higher proportion of the possible positioning range is above 51,200 and a smaller proportion below 51,200.

A special case is present if the upper mapping end is set so that the entire possible positioning range is at values $\geq 51,200$. With standard scaling (numerator = denominator = 400, i.e. 1 step = 0.9°) and referencing value = 0, this special case results if the relevant value from the following table is selected for the upper mapping end. The device then automatically adjusts the lower and upper limits accordingly.

Upper mapping end	152,400
Lower limit	51,200
Upper limit	151,200

Positioning range starts at 51,200

NOTICE

The numerator factor and denominator factor can be used to map any spindle resolutions. Using the referencing value, you can shift the whole range of values.

4.4.3. Shifting the positioning range downwards starting from the delivery state

In the following example, starting from the DS, the maximum possible positioning range is shifted slightly downwards using the parameter “upper mapping end”:

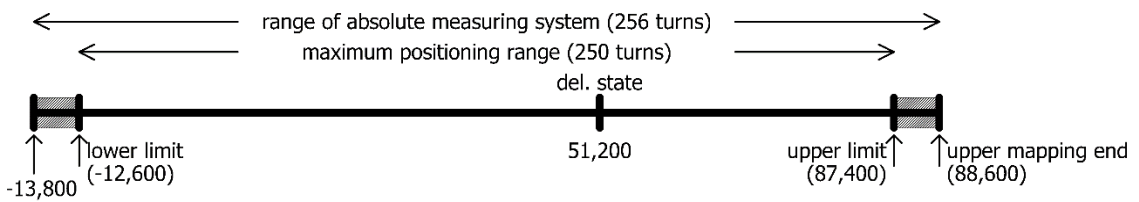

Here, the upper mapping end was decreased from the value 102,400 to 88,600. Consequently, a higher proportion of the possible positioning range is below 51,200 and a smaller proportion above 51,200.

A special case is present if the upper mapping end is set so that the entire possible positioning range is at values $\leq 51,200$. With standard scaling (numerator = denominator = 400, i.e. 1 step = 0.9°) and referencing value = 0, this special case results if the relevant value from the following table is selected for the upper mapping end. The device then automatically adjusts the lower and upper limits accordingly.

Upper mapping end	52,400
Lower limit	-48,800
Upper limit	51,200

Positioning range ends at 51,200

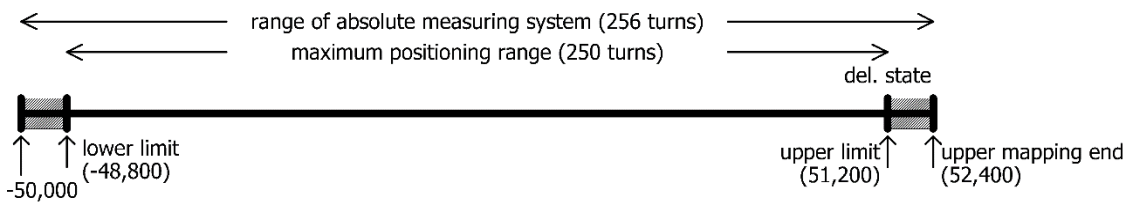

4.4.4. Shifting the positioning range depending on the actual position

Are (in contrast to the examples above) one or more of the parameters “numerator”, “denominator” and “referencing value” not in the delivery state, these are included in the calculation of the possible value range for the upper mapping end.

Please note that the measurement range of the absolute encoder is 256 rotations at the output shaft.

Starting from the delivery state, the possible positioning range may now be shifted

- by max. 256 rotations upwards
- by max. 256 rotations downwards

On the basis of these considerations the following value range results for the upper mapping end:

Minimum value for upper mapping end = referencing value + 1

Maximum value for upper mapping end =
referencing value + 204,800 * denom. / num. – 1

The following formulas result for the special case numerator = denominator:

Minimum value for upper mapping end = referencing value + 1

Maximum value for upper mapping end = referencing value + 204,799

(This is the case, e.g. for the delivery state where numerator = denominator = 400.)

NOTICE

Since the upper mapping end is an integer, the minimum and maximum values are obtained by rounding to the nearest integer (applies only to the case numerator \neq denominator).

NOTICE

If the actual position is no longer in the area
[upper mapping end - 256 rotations ... upper mapping end]
 after shifting the upper mapping end, the device then automatically adjusts the actual position accordingly. This is done by addition or subtraction of the number of steps which corresponds to 256 rotations. For the special case numerator = denominator this would be 102,400 steps.

Example:

- Spindle with 5 mm pitch, specified unit for target and actual values: 1µm
→ 1 rotation = 5mm = 5,000µm
→ Number of steps per rotation = 5,000
- Using the formula
Number of steps per rotation = 400 * denominator / numerator
the following result is obtained:
numerator = 400; denominator = 5,000
- With these settings, the drive is mounted and run using manual positioning commands, to a defined physical position (e.g. a specific mark along the run path) at which the actual position is to assume a specific value, e.g. the value 0.
- In our case, the position after running to this defined physical position shows, for example, the value 300,000. In this position, the actual value is set to zero. The device uses this information to calculate the new referencing value at 300,000.
→ Referencing value = 300,000
- The drive has a positioning range of 250 rotations (see above: Measurement range of the absolute encoder minus a safety margin of three rotations at both ends of the measurement range)
- In our case, these 250 rotations are to be divided in such a way that the drive can run 10 rotations (= 10 * 5,000 steps = 50,000 steps) from the zero position, just defined, to smaller values and 240 rotations (= 240 * 5,000 steps = 1,200,000 steps) to larger values.
- To ensure that the position value 1,200,000 is at the upper end of the maximum possible positioning range, as specified (i.e. at the upper limit), we add the safety margin of three rotations to this value and thus obtain our value for the upper mapping end:
upper mapping end = 1,200,000 + 3 * 5,000 = 1,215,000
- The device then recalculates the positioning range limits:
lower limit = upper mapping end - 253 * 5,000 = -50,000
upper limit = upper mapping end - 3 * 5,000 = 1,200,000
- This positioning range can then be restricted as required, i.e. the lower limit can be increased and the upper limit can be reduced.

4.4.5. Step-by-step instructions for determining the positioning range

The following section describes the procedure for determining those parameters that have an influence on the target and actual position as well as the positioning range. The individual steps must be carried out in the specified order.

- 1) **Setting the direction of rotation:**
The direction of rotation determines with which direction of rotation of the output shaft the position values increase and with which direction of rotation of the output shaft the position values decrease.

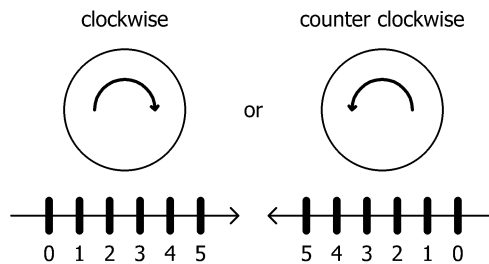

- 2) **Setting numerator and denominator:**
The numerator and denominator determine the number of steps into which one rotation of the output shaft is divided.

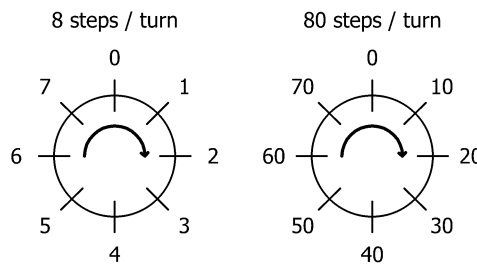

- 3) **Setting referencing value:**
The referencing value is used to assign a specific value of the actual position to a specific physical position of the axle.

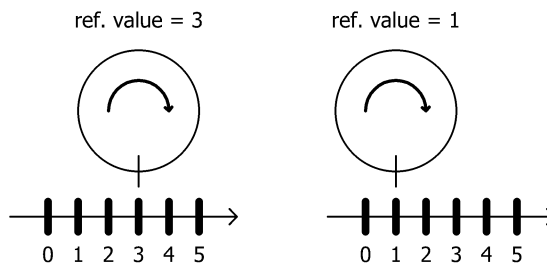

The referencing value is written either directly or by setting the actual position.

- 4) Setting upper mapping end:
The parameter defines the location of the maximum possible positioning range, taking into account the scaling values and the referencing value.

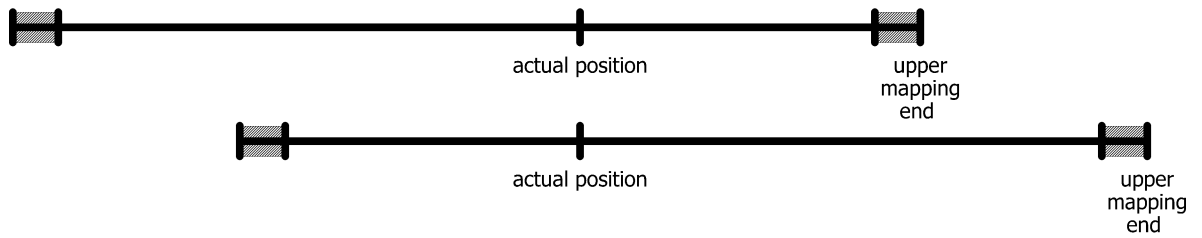

- 5) Setting upper and lower limits:
If necessary, the maximum possible positioning range can be restricted to prevent incorrect target positions that lead to a collision.

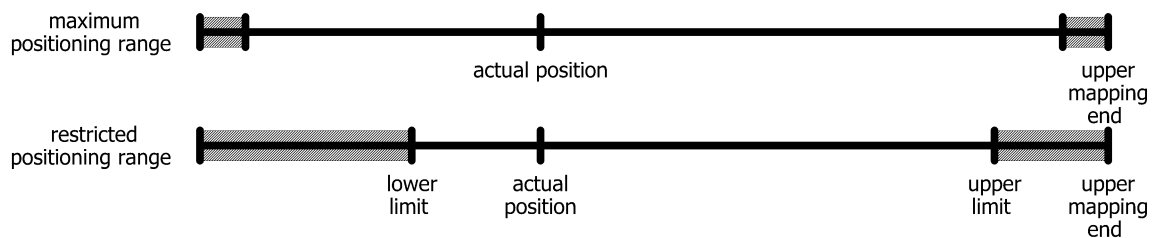

4.5. Readjustment

When P-0-0900 is set to the value 1, the drive performs a readjustment if it is pushed out of the positioning window after a run has been completed. If the loop length (S-0-0058) is not equal to 0, the drive will only readjust if it is pushed out of position in the direction of the loop. If the loop length = 0, the drive will readjust in both directions. If a stop command is sent, the drive will only readjust when a new run command is sent.

This function is only available for drives without brake.

4.6. Drag error

4.6.1. Monitoring

During a positioning run, the instrument compares the computed target position with the current actual value. If the difference is greater than the value "drag error" (S-0-0159), a warning (C2D) is generated (diagnosis code: 0xC00E2028). This applies in particular if the target speed cannot be achieved due to external influences (required torque, motor voltage too low). Monitoring of the drag error can be deactivated by setting S-0-0159 to 0.

4.6.2. Correction

The drag error correction can be activated with P-0-0159. The target rpm is increased or reduced by the specified factor proportionally to the drag error. It is recommended that you set the parameter to 4.

4.7. Absolute measuring system

The PSx3xxSE actuator includes an absolute measuring system capable of covering a range of 256 rotations. In order to prevent an overrun if an external force rotates the drive when it is switched off, the drive can be positioned in a range of 250 rotations. The three lower and upper rotations of the measurement range are therefore blocked.

NOTICE

Removal of the supply voltage to the motor has no effect on the internal measurement system.

4.7.1. Positioning range (S-0-0278)

S-0-0278 is used to map the desired positioning range onto the physical range of the machine. In the delivery state, the drive is at position 51200, the upper limit switch is set to 101200 and the lower limit switch is set to 1200, yielding a positioning range of ± 125 rotations (± 50000 increments). If the desired positioning range does not exceed ± 125 rotations, none of the steps described below are required to set the range.

The following two options are available to allow you to realise any desired positioning run distances independently of the run distance set by the mounting orientation of the measurement system (physical positioning range):

1. Bring the axle to be moved (e.g. a spindle) into the desired position, run the drive to the appropriate position with the adjustable collar open and then close the adjustable collar.

Examples:

Bring the axle to be positioned into the mid-position, run the drive to the mid-position (position 51200) with the adjustable collar open, then close the adjustable collar. The drive can now run 125 rotations in both directions (default ± 50000 increments).

Bring the axle to be positioned all the way to the left (or bottom), run the drive without a loop to the smallest position (position 1200) and with the adjustable collar open, and then close the adjustable collar. The drive can now run 250 rotations to the right (or top) (default ± 100000 increments).

Bring the axle to be positioned all the way to the right (or top), run the drive to the largest position (position 101200) with the adjustable collar open, then close the adjustable collar. The drive can now run 250 rotations to the left (or bottom) (default ± 100000 increments).

2. Mount the drive in the required position on the axle, close the adjustable collar, then adjust the positioning range using S-0-0278. The parameter sets the upper end of the positioning range. Default setting: upper end at +256 rotations (position 102400). If, after mounting the drive, the positioning range does not match the currently displayed position, you can select the positioning range between +3 ... +253 rotations from the current position as required.

Examples:

After mounting the drive, the position 51200 is displayed (this corresponds to the delivery state). The positioning range should point exclusively to the right (or top) → +253 rotations:

$$\begin{aligned} \text{Positioning range} &= \text{actual position} + \text{scale} * \text{number of rotations} \\ \text{S-0-0278} &= \text{S-0-0051} + (400 * \text{S-0-0079} / \text{P-0-0079}) * \text{number of rotations} \\ 152400 &= 51200 + (400 * 400 / 400) * 253 \end{aligned}$$

After mounting the drive, position 100000 is displayed. However, the positioning range should point exclusively to the right (or top) → +253 rotations:

$$\begin{aligned} \text{Positioning range} &= \text{actual position} + \text{scale} * \text{number of rotations} \\ \text{S-0-0278} &= \text{S-0-0051} + (400 * \text{S-0-0079} / \text{P-0-0079}) * \text{number of rotations} \\ 201200 &= 100000 + (400 * 400 / 400) * 253 \end{aligned}$$

After mounting the drive, position 2000 is displayed. However, the positioning range should point exclusively to the left (or bottom) → +3 rotations:

$$\begin{aligned} \text{Positioning range} &= \text{actual position} + \text{scale} * \text{number of rotations} \\ \text{S-0-0278} &= \text{S-0-0051} + (400 * \text{S-0-0079} / \text{P-0-0079}) * \text{number of rotations} \\ 3200 &= 2000 + (400 * 400 / 400) * 3 \end{aligned}$$

The numbers of increments or position values indicated relate to the following settings, which correspond to the delivery state:

Referencing value (S-0-0175) = 0

Scale for the positional data (S-0-0079 and P-0-0079) = 400

When the positioning range (S-0-0278) is changed, the upper limit is set to the value (positioning range – 3 rotations * scale) and the lower limit to the value (positioning range – 253 rotations * scale). This gives a total positioning range of 250 rotations.

4.7.2. Scale for the positional data (S-0-0079 and P-0-0079)

These parameters influence the number of increments generated per rotation.

The scale can be calculated using the following formula:

$$\frac{\text{increments}}{\text{rotation}} = \frac{400 * S - 0 - 0079}{P - 0 - 0079}$$

The most advisable approach is to leave P-0-0079 at 400 and then set the increments/rotation using S-0-0079.

Examples:

- The positional data should be scaled in degrees relating to the output shaft:
1 rotation = 360° → S-0-0079 = 360; P-0-0079 = 400
- The drive is to be operated on a 4mm spindle with a resolution of 1/100 mm:
1 rotation = 4 mm = 400 increments → S-0-0079 = 400; P-0-0079 = 400
- The drive is to be operated on a 4mm spindle with a resolution of 1/10 mm:
1 rotation = 4 mm = 40 increments → S-0-0079 = 400; P-0-0079 = 40
- The drive is to be operated on a 2mm spindle with a resolution of 1/100 mm:
1 rotation = 2 mm = 200 increments → S-0-0079 = 200; P-0-0079 = 200
- The drive is to count 138.23 increments per rotation:
1 rotation = 138.23 increments → S-0-0079 = 320; P-0-0079 = 926

When you change the scale for the positional data, the actual value, the referencing value, the positioning range, the upper and lower limits, the positioning window and the loop length are recalculated.

4.7.3. Direction of rotation (S-0-0055)

The direction of rotation allows you to specify in which direction the drive should rotate during runs to larger target values.

When looking at the output shaft, the following values are possible:

16: clockwise

23: counter clockwise

When you change the direction of rotation (S-0-0055), the referencing value (S-0-0175), the positioning range (S-0-0278) and the upper and lower limits (S-0-0049 and S-0-0050) are set to the delivery state.

4.7.4. Referencing (S-0-0175) and/or (S-0-0052)

Using the referencing value (S-0-0175) you can shift the whole range of values.

There are two ways of setting the referencing value:

Directly – by writing the referencing value in S-0-0175.

Indirectly – by writing a position value in S-0-0052. This allows any actual value to be assigned to the current actual value. The resulting difference is then the referencing value (in S-0-0175).

A change to the referencing value automatically shifts the actual value, positioning range and the upper and lower limits by the same value.

If the values of the upper mapping end and/or the limit switches (S-0-0049 and S-0-0050) are sent as standard with each upper move of the device, the new referencing value may have to be included in these values. This can be done, for example, by defining base values (which apply in the case of "referencing value = 0"), to which the respective current value of the referencing value is then added.

4.7.5. Setting parameters without automatic adjustment

If the user wants to avoid any automatic adjustment of values when setting the parameters for the drive, the optimum order for sending the parameters is as follows:

Direction of rotation (S-0-0055)

Scale for the positional data (S-0-0079)

Extended scale for the positional data (P-0-0079)

Referencing value (S-0-0175) and/or referencing of the position (S-0-0052)

Positioning range (S-0-0278)

Upper limit (S-0-0049)

Lower limit (S-0-0050)

Positioning window (S-0-0057)

Loop length (S-0-0058)

In order to save the settings permanently in the EEPROM, you must then use S-0-0264 (see Section 4.12.4 Commands).

5. Technical data

For additional specifications and dimension drawings, please visit our website at <https://www.halstrup-walcher.de/en/products/drive-technology/>



5.1. Ambient conditions

ambient temperature	0 °C to +45 °C		
storage temperature	-10 °C to +70 °C		
shock resistance according to DIN IEC 68-2-27	50 g 11 msec		
resistance to vibration according to DIN IEC 68-2-6	10 Hz to 55 Hz 1.5 mm 55 Hz to 1000 Hz 10 g 10 Hz to 2000 Hz 5 g		
EMC standards	CE		
conformity	CE / UKCA		
protection class	PSE	IP 54 / IP 65	
	PSS	IP 65	
	PSW	IP 66 (in operation) IP 68 (at standstill)	
duty cycle	Device model	Duty cycle in %	Base time in sec.
	PSE34xx	20	300
	PSE30xx to 33xx	30	300
	PSS	20	600
	PSW	20	600

5.2. Electrical data

Nominal power output	PSx30x, PSx31x, PSE31xx	25 W with 30 % OT
	PSx32x, PSx33x	35 W with 30 % OT
	PSE34xx	100 W with 20 % OT
Supply voltage	24 VDC ±10 % (supply voltages for motor and control unit are galvanically separated) Recommendation: Use a regulated power adapter	
Nominal current, control unit	0.15 A	
Nominal current, motor	PSx30x, PSx31x, PSE31xx	2.4 A
	PSx32x, PSx33x	3.1 A
	PSE34xx	7.8 A
Positioning resolution	0,9°	
Positioning accuracy	0.9°	
Absolute value acquisition	Optical - magnetic	

5.3. Physical data

Positioning range	250 usable rotations, no mechanical limits measuring system has a span of 256 turns, minus 3 turns security stock at upper and lower range limit	
torsional rigidity (angle of rotation when switching from operation without backlash to maximum torque)	max. 0.2°	
gear backlash (without spindle compensation run)	max. 0.5°	
Spindle lash compensation	Automatic reference loop after every positioning run (may be activated or deactivated)	
Output shaft	PSE30x-8, PSE31x-8	8H9 hollow shaft with adjustable collar
	PSE30x-14, PSE31x-14, PSE32x, PSE33x	14H7 hollow shaft with adjustable collar
	PSE31xx, PSE34xx	14H7 hollow shaft with clamp and feather key
	PSS3xx-8 PSW3xx-8	8H9 hollow shaft with adj. collar or 8h8 solid shaft
	PSS3xx-14 PSW3xx-14	14H7 hollow shaft with adj. collar or 14h8 solid shaft
recommended diameter of the spindle head	according to the hollow shaft diameter with an interference fit of h9	
Vibration emission	not in the harmful range	
Noise emission	not in the harmful range	
Maximum radial force	40 N	
Maximum axial force	20 N	
Dimensions (l x w x h)	see catalog data on our website	
Weight (approx.)	PSx30x-8	650 g
	PSx30x-14, PSx32x	1200 g
	PSx31x-8	700 g
	PSx31x-14, PSx33x	700 g
	PSE31xx	1200 g
	PSE34xx	1900 g

6. Certificate of Conformity



EU-Konformitätserklärung EU Declaration of Conformity

Company	halstrup-walcher GmbH, Stegener Str. 10, 79199 Kirchzarten erklärt als Hersteller in alleiniger Verantwortung, dass das Produkt declares as manufacturer under sole responsibility, that the product
Product	Positionierantriebe Baureihen PSE3xx, PSS3xx, PSW3xx Positioning Systems Series PSE3xx, PSS3xx, PSW3xx
Regulations	den folgenden Europäischen Richtlinien entspricht: conforms to following European Directives: EMC 2014/30/EU RoHS 2011/85/EU
Standards	angewandte harmonisierte Normen: applied harmonized standards: EN IEC 61800-3:2018 EN IEC 63000:2018
Certification	EU Konformitätserklärung ausgestellt von EC Type Examination Certificate issued by



Geschäftsführer

Managing Director

Kirchzarten,

14. Okt. 2020

14. Oct. 2020



UK Declaration of Conformity

Company halstrup-walcher GmbH, Stegener Str. 10, 79199 Kirchzarten, Germany
declares as manufacturer under sole responsibility, that the product

Product Positioning System Models PSE3xx / PSS3xx / PSW3xx

Regulations is in conformity with relevant statutory requirements:

EMC Electromagnetic Compatibility Regulations 2016 No. 1091
RoHS RoHS Regulations 2012 No. 3032

Standards applied standards:

EN 55011:2016+A1:2017; EN 61000-6-2:2005; EN 61800-3:2004/ A1:2012
EN IEC 63000:2018

Declaration signed for and on behalf of



Geschäftsführer

Managing Director

Kirchzarten, 26. Jan. 2022

halstrup-walcher GmbH
Stegener Straße 10
79199 Kirchzarten

Telefon: +49 (0) 7661 3963-0
Fax: +49 (0) 7661 3963-99
E-Mail: info@halstrup-walcher.de

Geschäftsführer: Jürgen Walcher, Christian Sura
Handelsregister Amtsgericht Freiburg HRB 2209
Umsatzsteuer-ID-Nr. DE 811169901

